

033



Bone Surgery
Knochenchirurgie
Cirurgia ósea
Chirurgie osseuse
Chirurgia ossea



Bone Levers
Knochenhebel
Elevadores para huesos
Leviers à os
Leve per ossa



033

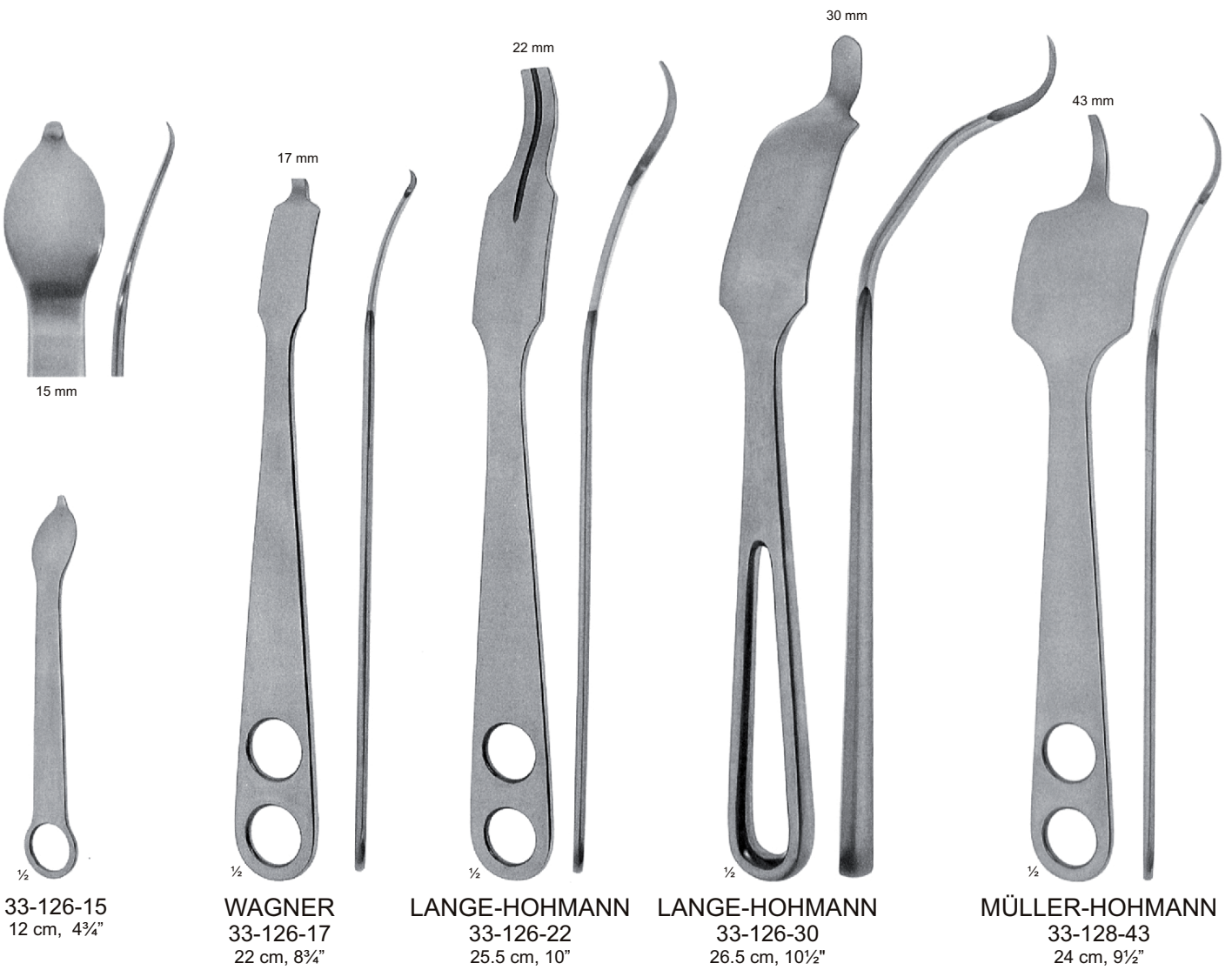



Bone Levers
Knochenhebel
Elevadores para huesos
Leviers à os
Leve per ossa



033

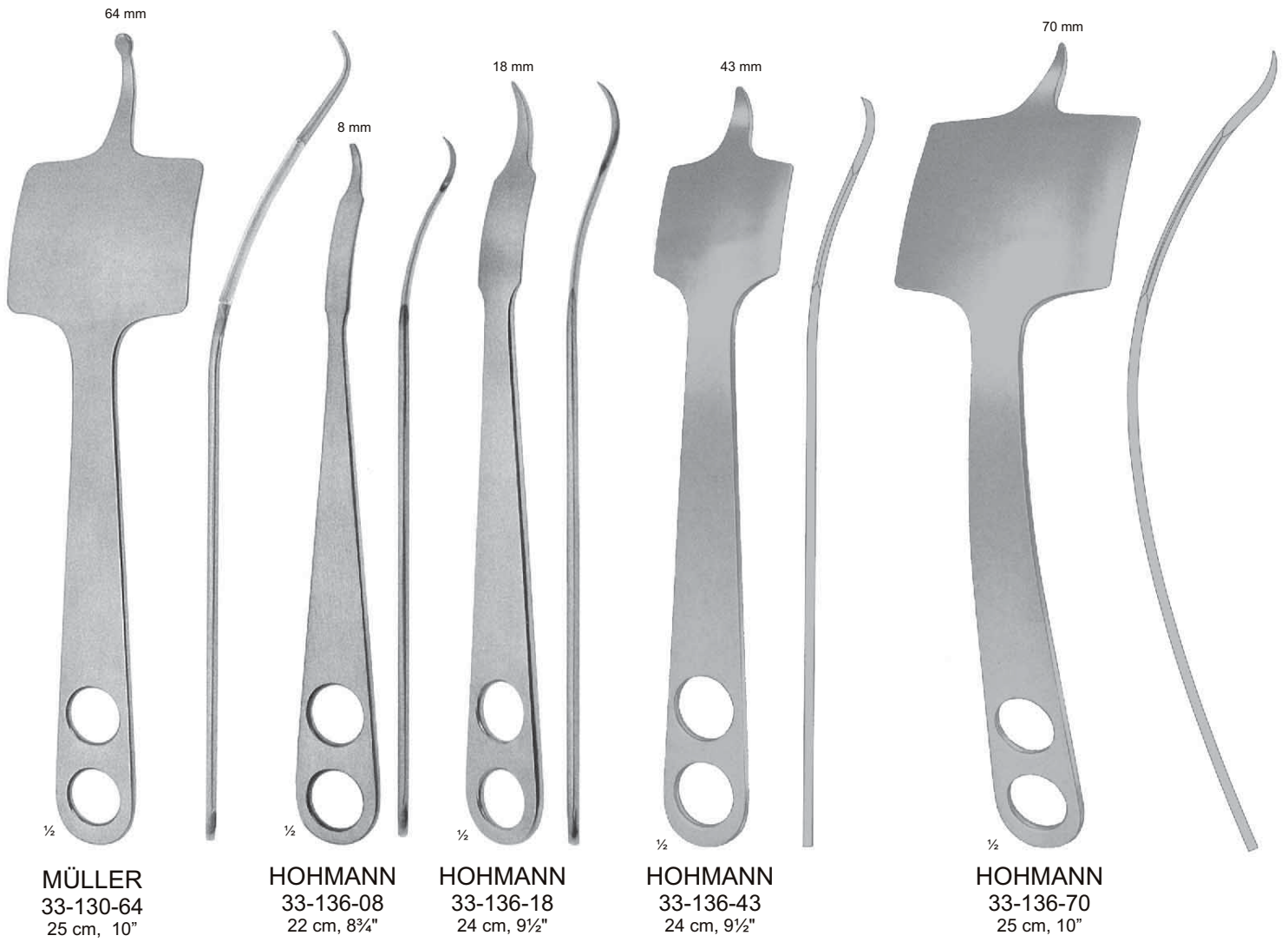

**Bone Levers**

Knochenhebel
Elevadores para huesos
Leviers à os
Leve per ossa

Hib levers

Hüfthebel
Elevadores para caderas
Elévateurs pour la hanche
Leve per sciatica



033

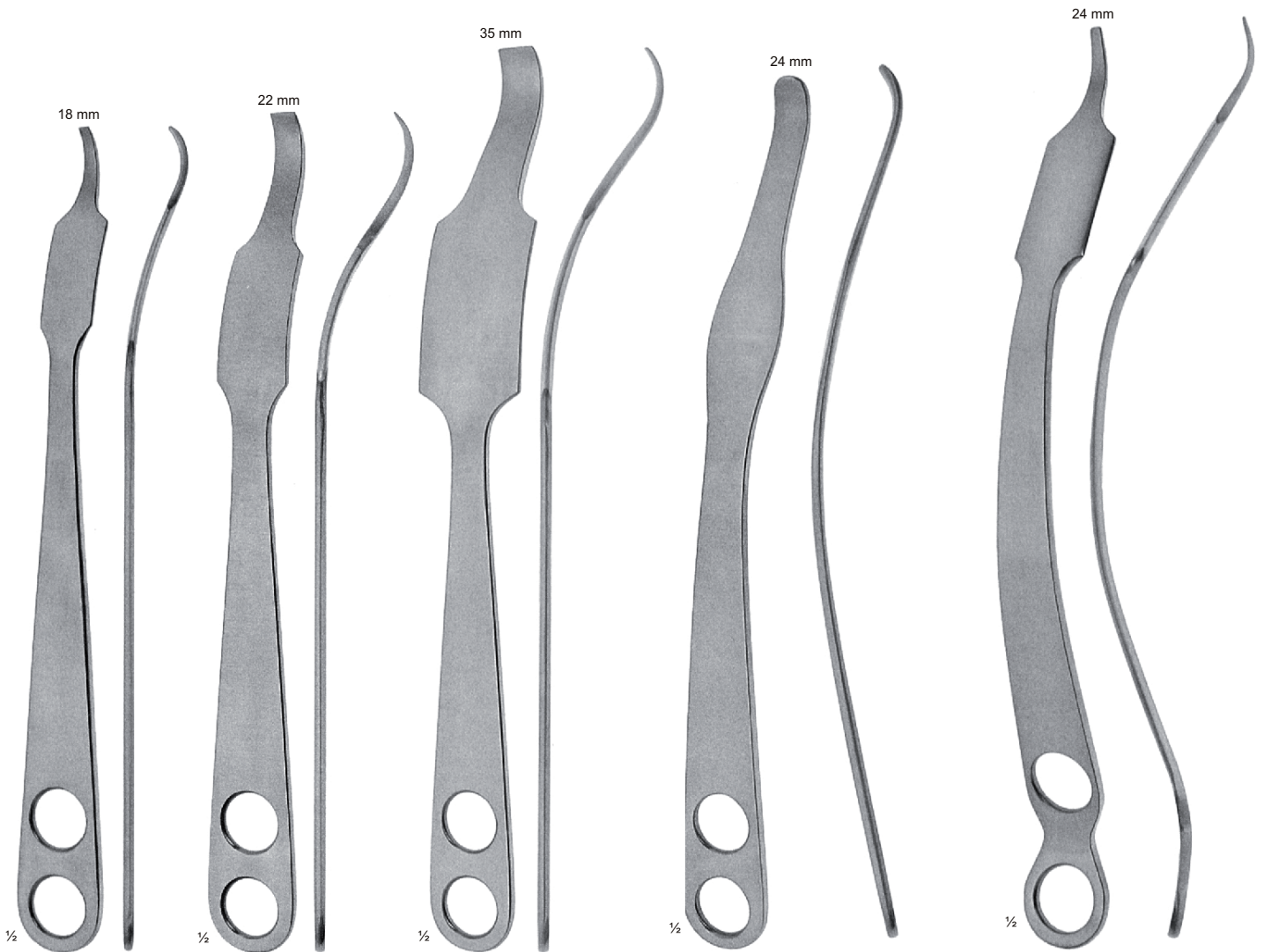

$\frac{1}{2}$
HOHMANN
33-140-18
25 cm, 10"

$\frac{1}{2}$
HOHMANN
33-140-22
26 cm, 10 $\frac{1}{4}$ "

$\frac{1}{2}$
HOHMANN
33-140-35
28,5 cm, 11 $\frac{1}{4}$ "

$\frac{1}{2}$
HOHMANN
33-146-24
27 cm, 10 $\frac{3}{4}$ "

$\frac{1}{2}$
HOHMANN-ALDINGER
33-148-24
28,5 cm, 11 $\frac{1}{4}$ "

Bone Lever
Knochenhebel
Elevador para hueso
Levier à os
Leve per ossa

Bone Lever
Knochenhebel
Elevador para hueso
Levier à os
Leve per ossa



Hib levers

Hüfthebel
Elevadores para caderas
Elévateurs pour la hanche
Leve per sciatica

Bone Levers

Knochenhebel
Elevadores para huesos
Leviers à os
Leve per ossa



033

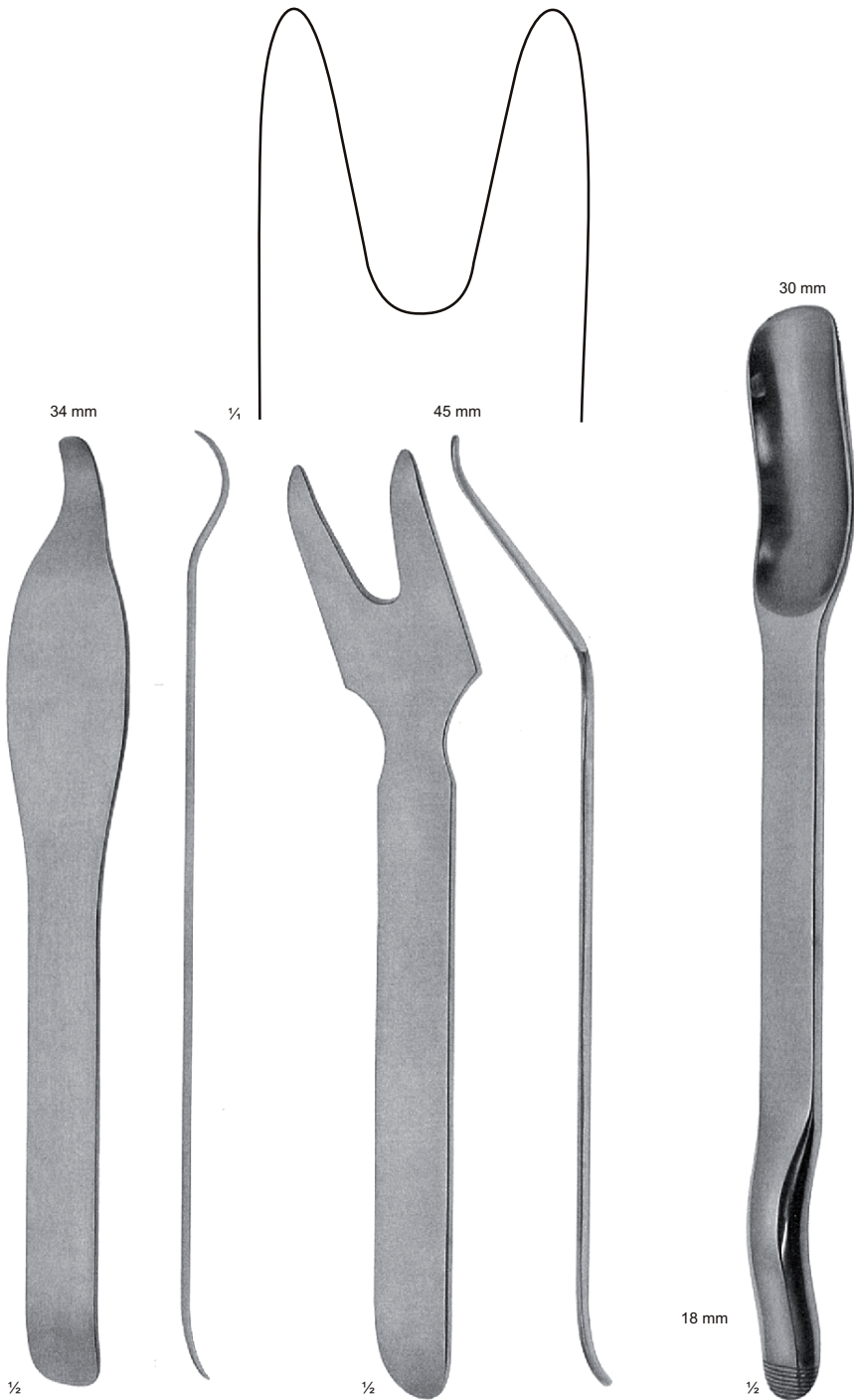

BLOUNT
33-150-34
26 cm, 10 1/4"

BLOUNT
33-160-45
26 cm, 10 1/4"

Hib lever
Hüfthebel
Elevador para cadera
Elévateur pour la hanche
Leve per sciatica

MURPHY-LANE
33-162-30
30 cm, 12"

Luxation lever
Luxationshebel
Elevadore para luxación
Leviers pour luxation
Leve per lussazione

Hib lever
Hüfthebel
Elevador para cadera
Elévateur pour la hanche
Leve per sciatica

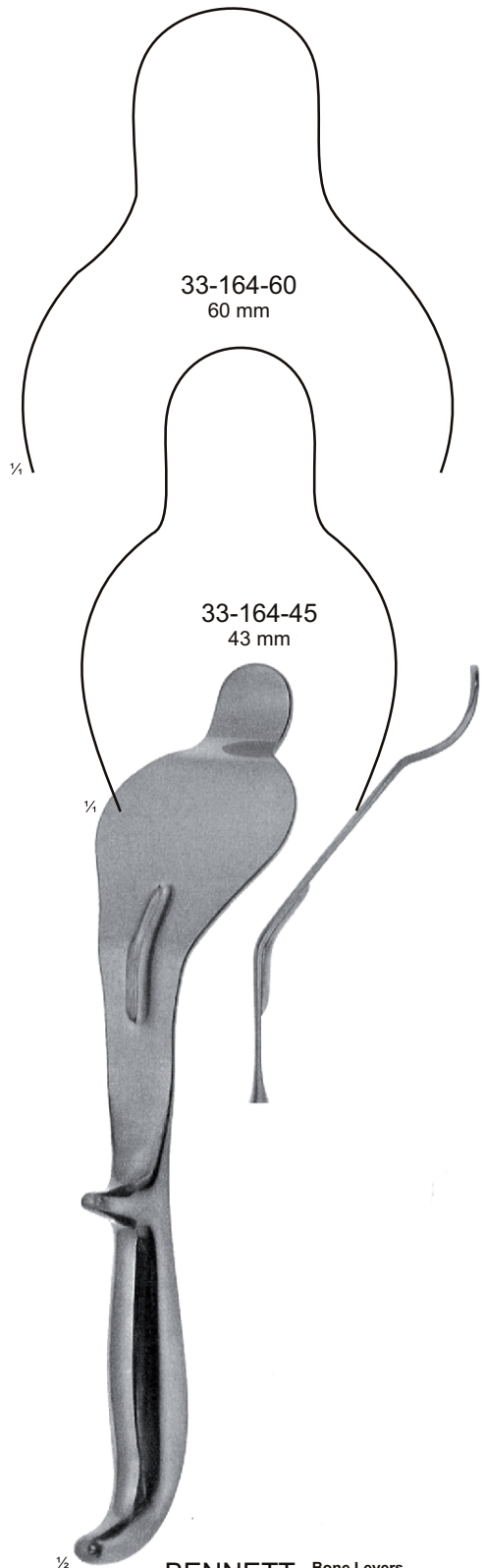

BENNETT
33-164-45
33-164-60
24 cm, 9 1/2"

Bone Levers
Knochenhebel
Elevadores para huesos
Leviers à os
Leve per ossa

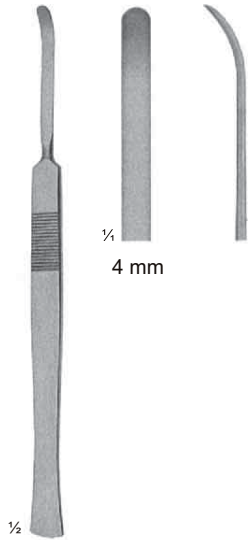

McKENTY
 33-170-14
 14,5 cm, 5³/₄"

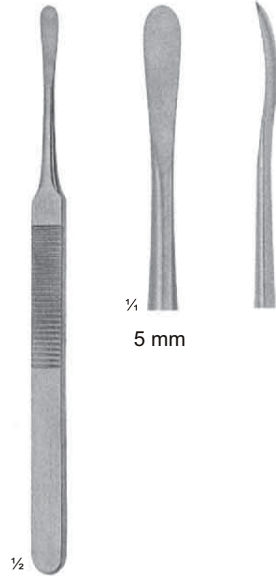

KONIG
 33-174-15
 15,5 cm, 6"



WILLIGER
 33-178-13
 33-178-16

33-178-13
 13 cm, 5"
 4 mm



33-178-16
 16 cm, 6¹/₄"
 6 mm

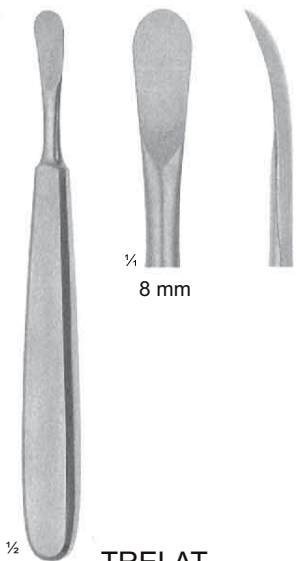

TRELAT
 33-182-15
 15 cm, 6"

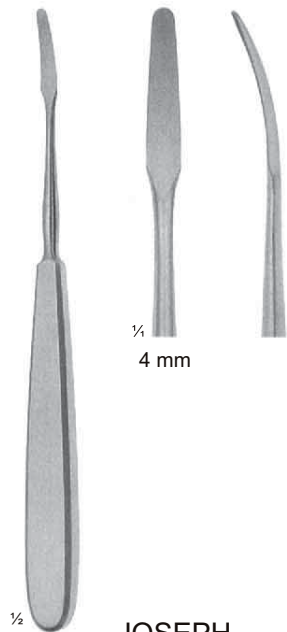

JOSEPH
 33-186-17
 17 cm, 6³/₄"

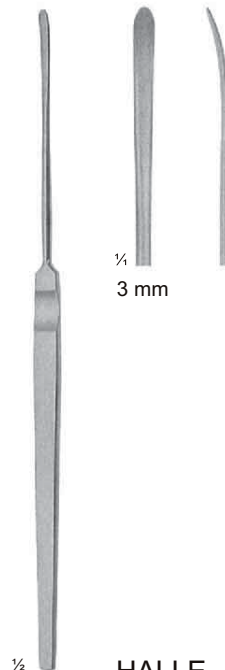

HALLE
 33-188-16
 16,5 cm, 6¹/₂"

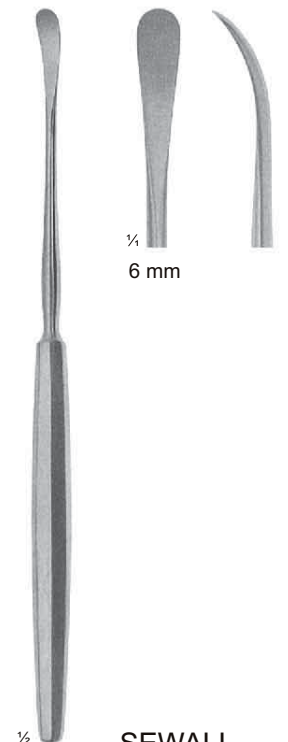

SEWALL
 33-190-20
 20 cm, 8"



Blunt
 Stumpf
 Romo
 Mousse
 Smusso

¼
 4,5 mm

¼
 6,5 mm

Sharp
 Scharf
 Agudo
 Pointu
 Acuto

¼
 4,5 mm

¼
 6,5 mm

FREER
 33-200-04
 33-200-06
 18 cm, 7"

½

Blunt
 Stumpf
 Romo
 Mousse
 Smusso

¼
 4,5 mm

Sharp
 Scharf
 Agudo
 Pointu
 Acuto

¼
 4,5 mm

FREER
 33-204-01
 33-204-02
 19 cm, 7½"

½

MILLIAN
 33-208-18
 18 cm, 7"

¼

¼

½

¼
 5,5 mm

¼
 4,5 mm

HOWARD
 33-210-21
 21,5 cm, 8½"

½

¼

¼

COTTLE
 33-216-23
 23 cm, 9"

½

¼

¼

33-220-01
 17 cm, 6¾"
 6 mm

33-220-02
 17 cm, 6¾"
 8 mm

¼

¼

½

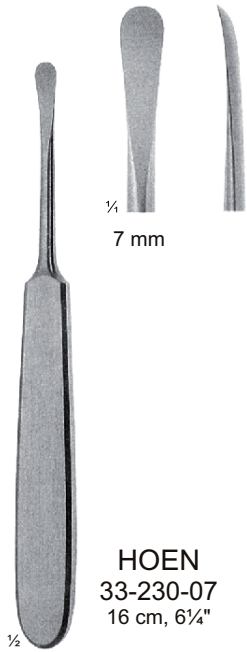

¼
 7 mm

HOEN
 33-230-07
 16 cm, 6¼"

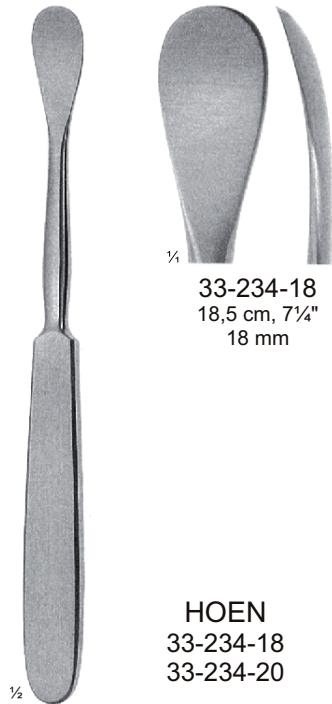

¼
33-234-18
 18,5 cm, 7¼"
 18 mm

HOEN
 33-234-18
 33-234-20

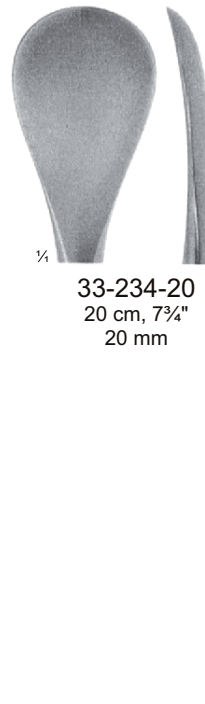

¼
33-234-20
 20 cm, 7¾"
 20 mm

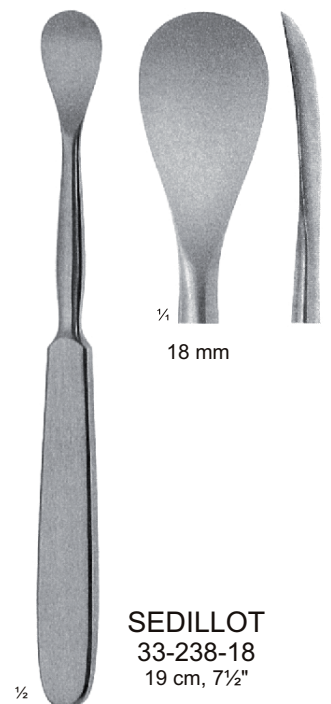

¼
 18 mm

SEDILLOT
 33-238-18
 19 cm, 7½"

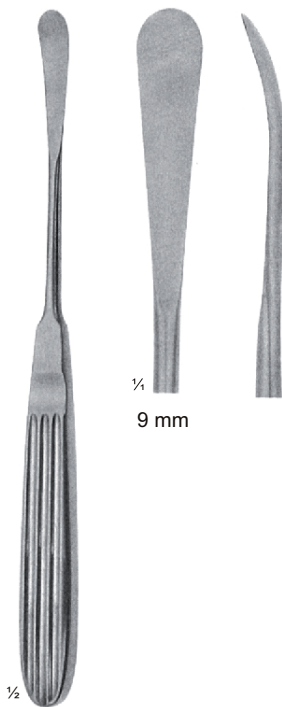

¼
 9 mm

COTTLE
 33-240-09
 19 cm, 7½"

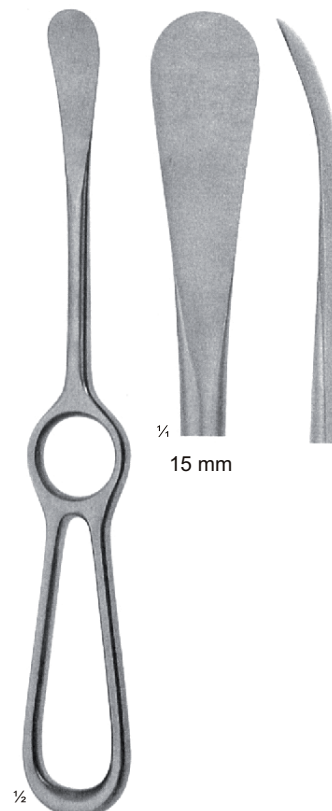

¼
 15 mm

SEDILLOT
 33-244-15
 21 cm, 8¼"

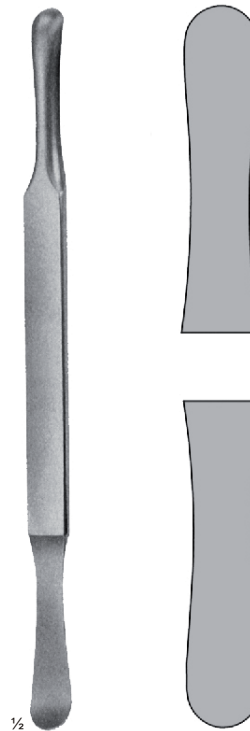

¼

SELDIN
 33-246-19
 19,5 cm, 7½"

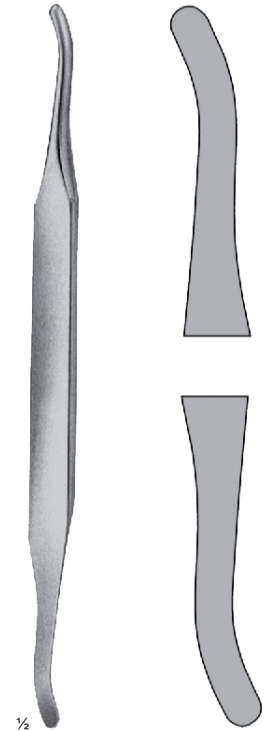

¼

SELDIN
 33-248-19
 19,5 cm, 7½"

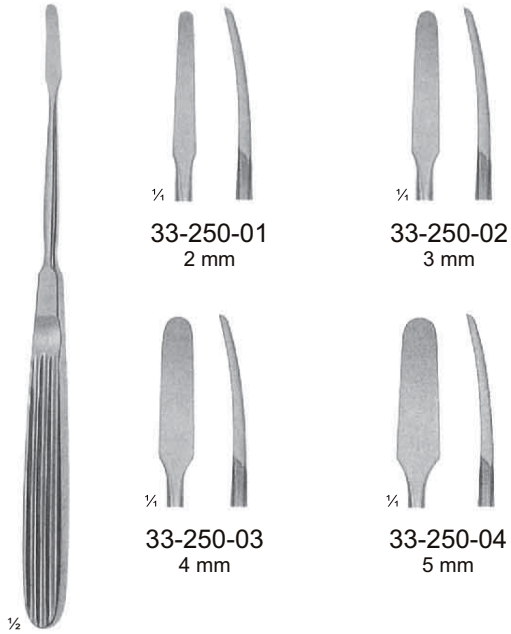

LEMPERT
 33-250-01
 33-250-04
 17 cm, 6³/₄"

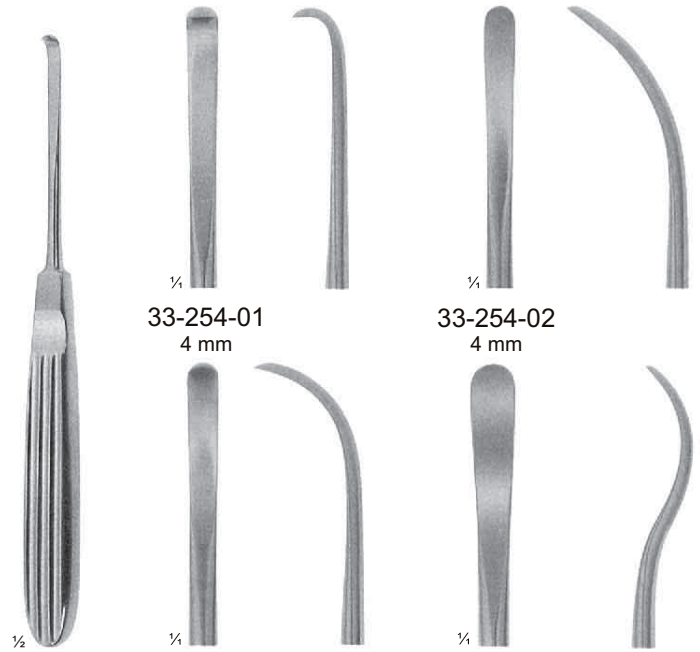

MUHLING
 33-254-01
 33-254-01
 33-254-04
 17 cm, 6³/₄"



ADSON
 33-256-01
 33-256-04
 17 cm, 6³/₄"

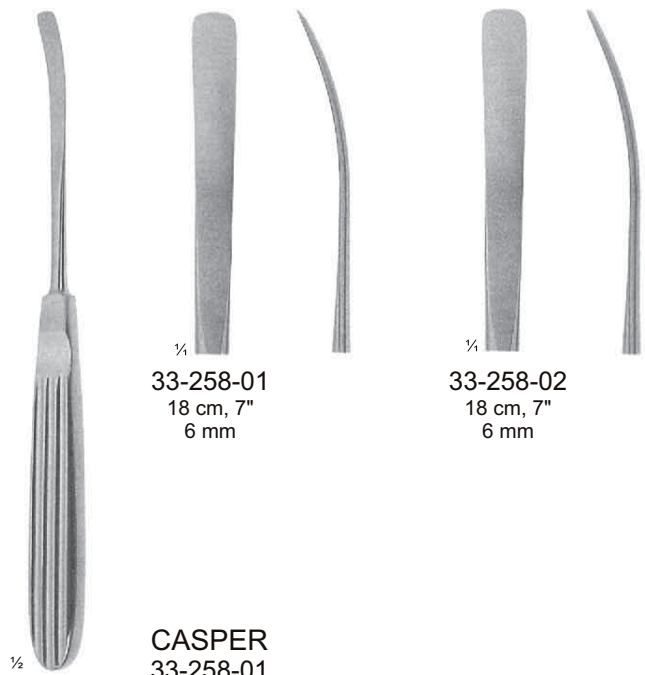

CASPER
 33-258-01
 33-258-02
 18 cm, 7"

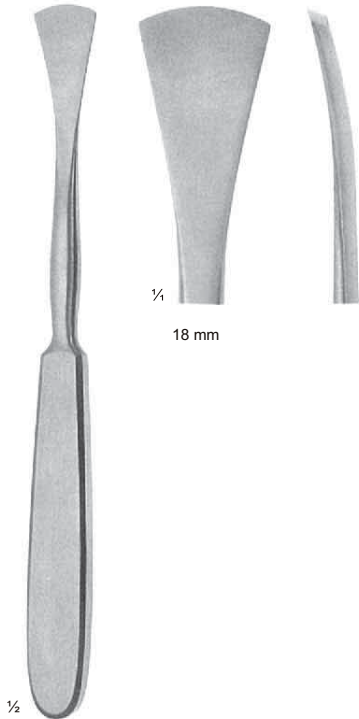

LANGENBECK
 33-260-19
 19 cm, 7½"

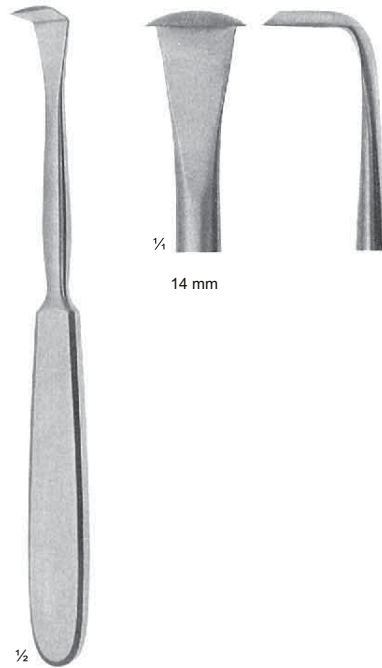

LANGENBECK
 33-264-18
 18 cm, 7"

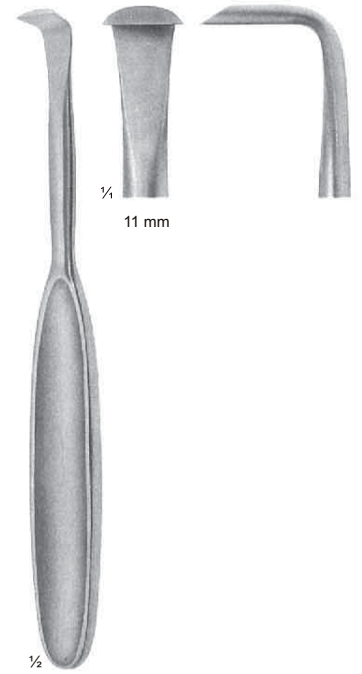

LANGENBECK
 33-268-18
 18 cm, 7"

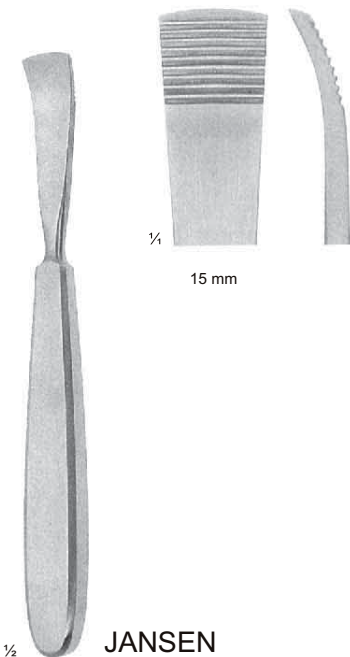

JANSEN
 33-270-15
 16,5 cm, 6½"



33-272-01
 19 cm, 7½"



33-272-02
 19 cm, 7½"



33-272-03
 19 cm, 7½"

LANGENBECK
 33-272-01
 33-272-03



Raspatories
 Raspatorien
 Periostótomos
 Rugines-raspatoires
 Periostotomi



033



¼
 13 mm

½
SCHNEIDER
 33-280-17
 17,5 cm, 7"

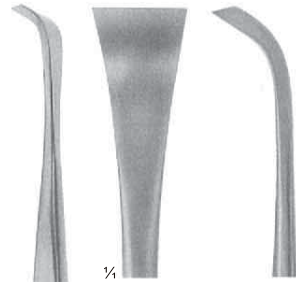

¼
 13 mm

½
SAUERBRUCH
 33-282-19
 19 cm, 7½"

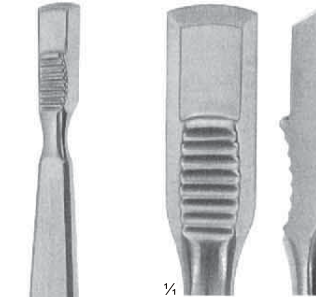

¼
33-284-15
 15 cm, 6"
 12,5 mm

½
FRABEUF
 33-285-15
 33-285-15

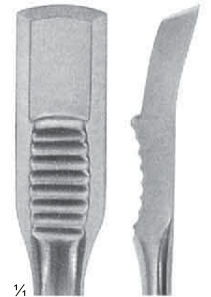

¼
33-285-15
 15 cm, 6"
 12,5 mm

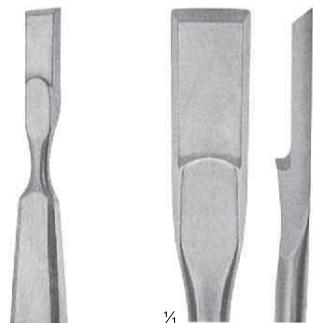

¼
33-288-15
 15 cm, 6"
 11 mm

½
**FRABEUF
 COLLIN**
 33-288-11
 33-288-11



¼
33-289-15
 15 cm, 6"
 11 mm



½
COBB
 33-296-01
 33-296-04
 28,5 cm 11¼"



¼
33-296-01
 10 mm



¼
33-296-02
 13 mm





¼
33-296-03
 19 mm



¼
33-296-04
 25 mm





 33-300-03
 17,5 cm, 7"
 3 mm

 33-300-06
 17,5 cm, 7"
 6,5 mm

 33-300-09
 19 cm, 7½"
 9,5 mm

 33-300-12
 19 cm, 7½"
 12,5 mm

 33-300-16
 20 cm, 8"
 16,0 mm



 33-300-19
 20 cm, 8"
 19,5 mm



 33-300-24
 21 cm, 8¼"
 24,5 mm

 KEY
 33-300-03
 33-300-24



 33-304-18
 18 cm, 7"
 6 mm

 33-306-18
 18 cm, 7"
 3 mm

 33-304-18
 33-306-18



 33-308-01
 18 cm, 7"
 6 mm

 33-308-02
 18 cm, 7"
 6 mm

 33-308-01
 33-308-02

 33-310-13
 20 cm, 8"
 13 mm

 33-310-20
 20 cm 8"
 20 mm

 33-310-13
 33-310-20

 33-316-12
 20 cm, 8"
 12 mm

 33-317-13
 20 cm, 8"
 13 mm















 33-316-12
 33-317-13



Raspatories with handle from artificial wood
 Raspatorien mit Ferrozellgriff
 Periostómtomos con mango de madera artificial
 Rugines-raspatoires avec manche en " Ferrozell "



033

 <p>33-320-08 33 cm, 13" 8 mm</p>	 <p>33-324-04 25 cm, 10" 10 mm</p>  <p>33-326-06 25 cm, 10" 6 mm</p>  <p>33-324-08 25 cm, 10" 8 mm</p>	 <p>33-324-10 25 cm, 10" 10 mm</p>  <p>33-324-13 25 cm, 10" 13 mm</p>  <p>33-324-10 25 cm, 10" 19 mm</p>  <p>33-328-21 27,5 cm, 10 3/4" 21 mm</p>
 <p>33-320-17 33 cm, 13" 17 mm</p> <p>WAGNER 33-320-08 33-320-17</p>	   <p>COBB 33-324-08 33-324-25</p>	 



Bone Files
 Knochenfeilen
 Limas para huesos
 Limes à os
 Lime per ossa

Rasps
 Raspeln
 Escófinas
 Râpes
 Raspe



033



GALLAHER
 33-330-16
 16 cm, 6¼"



MILLER
 33-334-01
 33-334-03

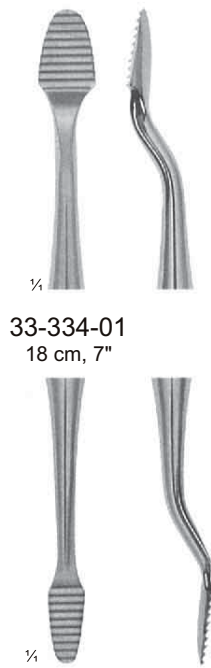

33-334-01
 18 cm, 7"



33-334-02
 18 cm, 7"



33-334-03
 18 cm, 7"

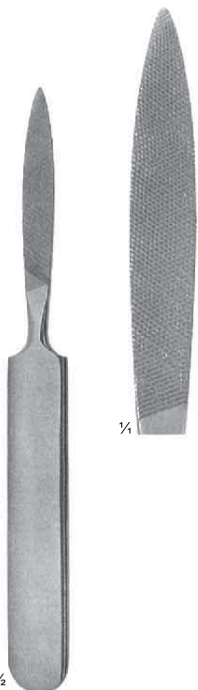

JOSEPH
 33-338-16
 16 cm, 6¼"

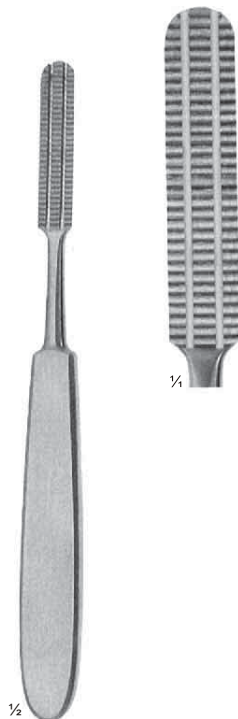

MALTZ
 33-340-18
 18 cm, 7"



LEWIS
 33-342-01
 33-342-02



33-342-01
 18 cm, 7"

Fine
 Fein
 fina
 denture fine
 dentatura fina



33-342-02
 18 cm, 7"

Coarse
 Grob
 Gruesa
 Denture grosse
 Dentatura grossa



Bone Files
 Knochenfeilen
 Limas para huesos
 Limes à os
 Lime per ossa

Rasps
 Raspeln
 Escofinas
 Râpes
 Raspe



033

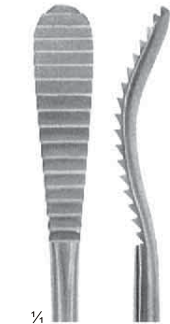

33-350-01
 21 cm, 8¼"
Up stroke
 Auf Druck
 A presión
 à pousser
 A pressione



33-350-02
 21 cm, 8¼"
Down stroke
 Auf Zug
 A tracción
 à tirer
 A trazione

AUFRICHT
 33-350-01
 33-350-02



33-360-01
Fine
 Fein
 Fina
 Denture fine
 Dentatura fina

33-360-02
Coarse
 Grob
 Gruesa
 Denture grosse
 Dentatura grossa



FOMON
 33-360-01
 33-360-02
 20 cm, 8"

File cut / rasp cut
 Feilenhieb / Respelhieb
 Filo de lima / filo de escofina
 Coupe lime / coupe râpe
 Taglio di lima / taglio di raspa



COTTLE
 33-354-21
 21 cm, 8¼"



BRAWLEY
 33-358-19
 19,5 cm, 7¾"



Bone Files
 Knochenfeilen
 Limas para huesos
 Limes à os
 Lime per ossa



033



¼
33-362-01
 18 cm, 7"
 ø 3,5 mm



¼
33-362-02
 18 cm, 7"
 ø 3,5 mm



½
WIENER
 33-362-01
 33-362-02



10 mm
 16 mm
 ½
PUTTI
 33-264-30
 30 cm, 12"



20 mm
 18 mm
 ½
PUTTI
 33-366-27
 27 cm, 10½"

File cut / rasp cut
 Feilenhieb / Respelhieb
 Filo de lima / filo de escofina
 coupe lime / coupe râpe
 Taglio di lima / taglio di raspa



20 mm
 ¼
33-368-22
 22 cm, 8¾"



20 mm
 ½
33-370-28
 28 cm, 11"



13 mm
 ¼
33-372-24
 24,5 cm, 9¾"

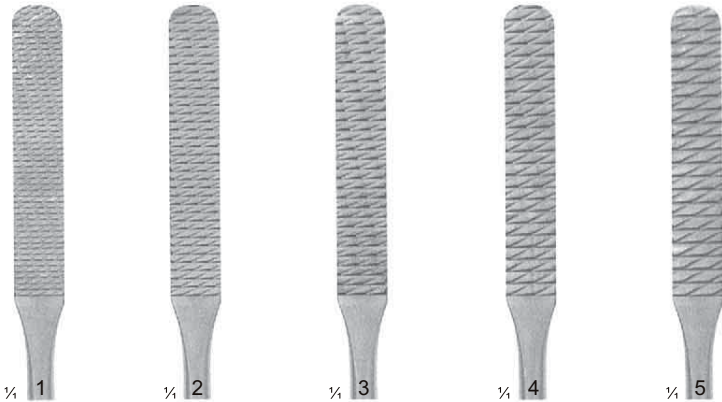

¼ 1	¼ 2	¼ 3	¼ 4	¼ 5
57-100-01	57-100-02	57-100-03	57-100-04	57-100-05
12 Teeth 12 Zähne 12 Dientes 12 Dents 12 Denti	14 Teeth 14 Zähne 14 Dientes 14 Dents 14 Denti	16 Teeth 16 Zähne 16 Dientes 16 Dents 16 Denti	20 Teeth 20 Zähne 20 Dientes 20 Dents 20 Denti	24 Teeth 24 Zähne 24 Dientes 24 Dents 24 Denti

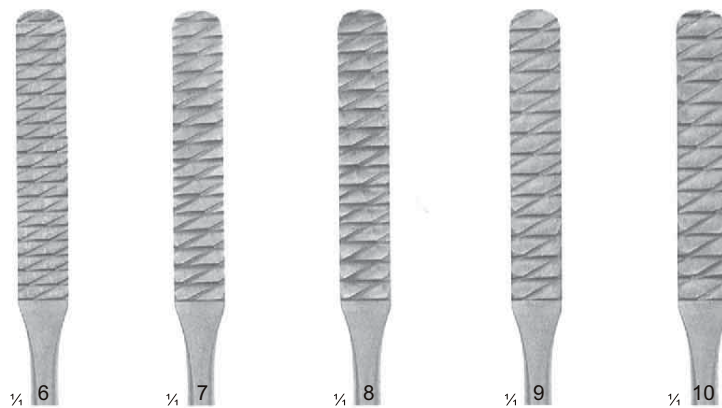

¼ 6	¼ 7	¼ 8	¼ 9	¼ 10
57-100-06	57-100-07	57-100-08	57-100-09	57-100-10
30 Teeth 30 Zähne 30 Dientes 30 Dents 30 Denti	36 Teeth 36 Zähne 36 Dientes 36 Dents 36 Denti	44 Teeth 44 Zähne 44 Dientes 44 Dents 44 Denti	52 Teeth 52 Zähne 52 Dientes 52 Dents 52 Denti	62 Teeth 62 Zähne 62 Dientes 62 Dents 62 Denti



COTTLE
 57-100-01
 57-100-10
 21 cm, 8¼"

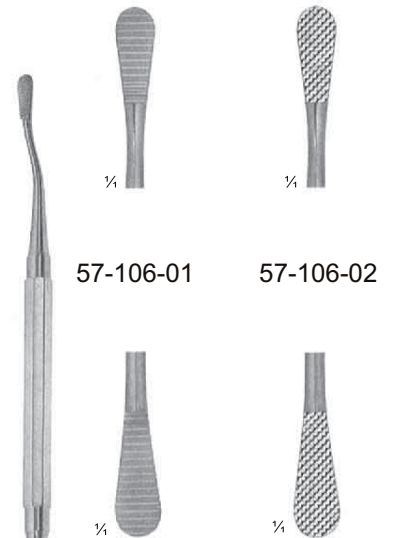

MILLER
 57-106-01
 57-106-02
 18,5 cm, 7¼"



Rasps with tungsten carbide inserts
 Raspeln mit Hartmetalleinlagen
 Escofinas con bocas de carburo tungsteno
 Râpes avec mors en tungstène
 Raspe con inserti in carburo di tungsteno

**ROCK CUT**

033

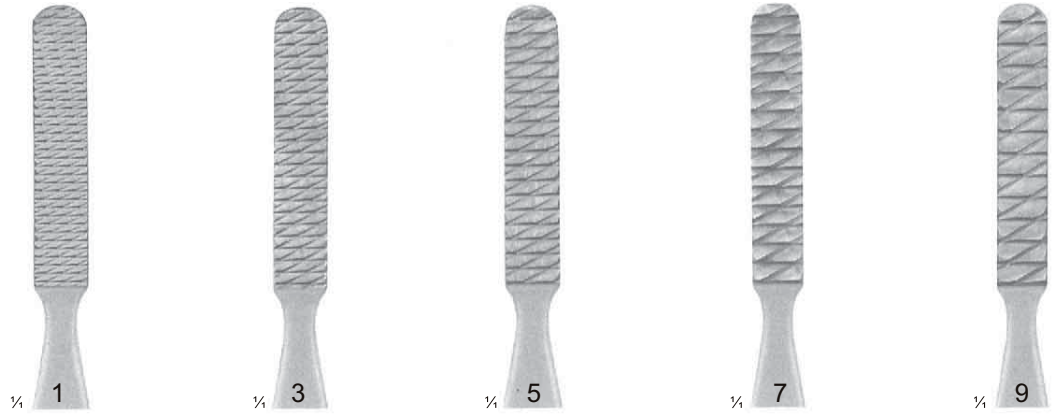

57-110-01

12/14 Teeth
 12/14 Zähne
 12/14 Dientes
 12/14 Dents
 12/14 Denti

57-110-02

16/20 Teeth
 16/20 Zähne
 16/20 Dientes
 16/20 Dents
 16/20 Denti

57-110-03

24/30 Teeth
 24/30 Zähne
 24/30 Dientes
 24/30 Dents
 24/30 Denti

57-110-04

36/44 Teeth
 36/44 Zähne
 36/44 Dientes
 36/44 Dents
 36/44 Denti

57-110-05

52/62 Teeth
 52/62 Zähne
 52/62 Dientes
 52/62 Dents
 52/62 Denti



1/2



2



4



6



8



10

FOMON
 57-110-01
 57-110-05
 20 cm, 8"

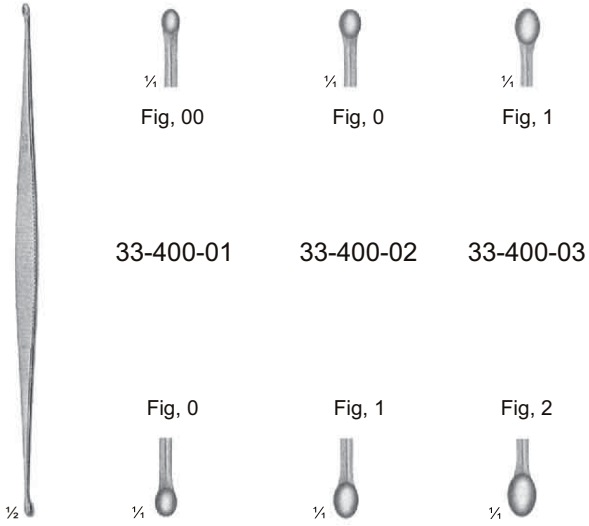

WILLIGER
 33-400-01
 33-400-03
 13,5 cm, 5¼"

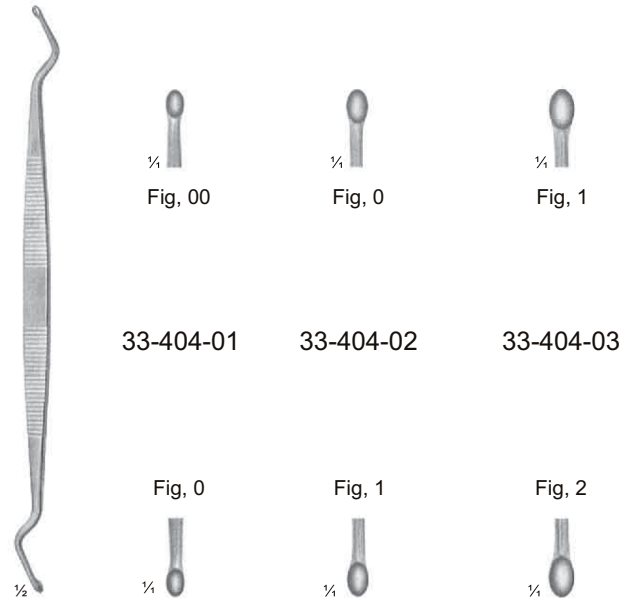

WILLIGER
 33-404-01
 33-404-03
 16 cm, 6¼"

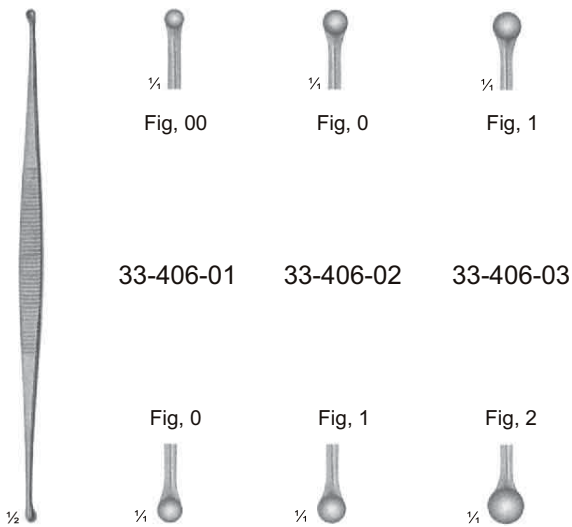



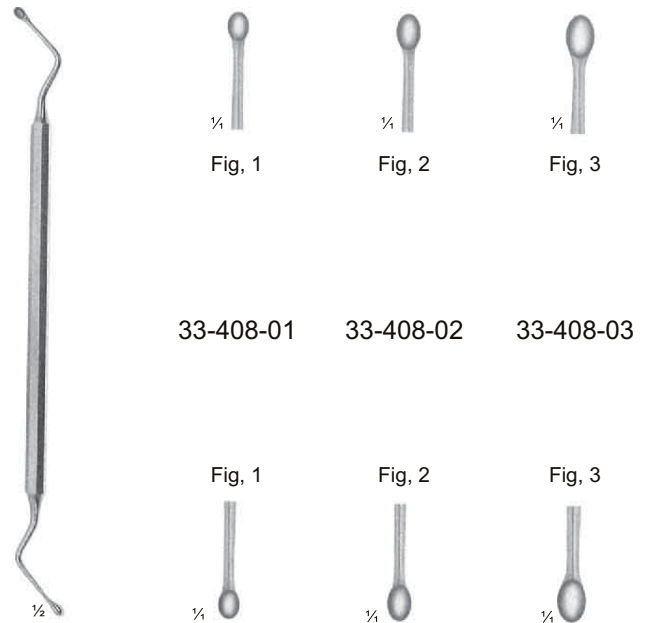















MARTINI
 33-406-01
 33-406-03
 13,5 cm, 5¼"













HEMINGWAY
 33-408-01
 33-408-03
 16,5 cm, 6½"



MOD-USA
 33-450-01
 33-453-06
 16 cm, 6¼"

 33-450-01 Fig. 1	 33-450-02 Fig. 2	 33-450-03 Fig. 3
 33-450-04 Fig. 4	 33-450-05 Fig. 5	 33-450-06 Fig. 6
 33-451-01 Fig. 1	 33-451-02 Fig. 2	 33-451-03 Fig. 3
 33-451-04 Fig. 4	 33-451-05 Fig. 5	 33-451-06 Fig. 6
 33-453-01 Fig. 1	 33-453-02 Fig. 2	 33-453-03 Fig. 3
 33-453-04 Fig. 4	 33-453-05 Fig. 5	 33-453-06 Fig. 6







SPRATT
 33-456-01
 33-456-10
 16 cm, 6¼"

 33-456-01 Fig. 0000	 33-456-02 Fig. 000	 33-456-03 Fig. 00
 33-456-04 Fig. 0	 33-456-05 Fig. 1	 33-456-06 Fig. 2
 33-456-07 Fig. 3	 33-456-08 Fig. 4	 33-456-09 Fig. 5
		 33-456-10 Fig. 6

UFFENORDE
 33-457-01
 33-459-02

 33-457-01 17 cm, 6¾"	 33-459-02 17 cm, 6¾"
--	--









SCHEDE
 33-460-01
 33-460-07
 17 cm, 6¾"

 33-460-01 Fig. 000	 33-460-02 Fig. 00	 33-460-03 Fig. 0	 33-460-04 Fig. 1
	 33-460-05 Fig. 2	 33-460-06 Fig. 3	 33-460-07 Fig. 4

Bone Curettes











Scharfe Löffel
Cucharillas cortantes
Curettes
Curette per ossa



- | | | | |
|---|--|--|--|
| 
33-470-01
Fig, 00 | 
33-470-02
Fig, 0 | 
33-470-03
Fig, 1 | 
33-470-04
Fig, 2 |
| 
33-472-01
Fig, 00 | 
33-472-02
Fig, 0 | 
33-472-03
Fig, 1 | 
33-472-04
Fig, 2 |











WILLIGER
33-470-01
33-472-04
17,5 cm, 7"



- | | | |
|---|--|---|
| 
33-476-01
Fig, 0000 | 
33-476-02
Fig, 000 | 
33-476-03
Fig, 00 |
| 
33-476-04
Fig, 0 | 
33-476-05
Fig, 1 | 
33-476-06
Fig, 2 |
| 
33-476-07
Fig, 3 | 
33-476-08
Fig, 4 | 
33-476-09
Fig, 5 |
| | | 
33-476-10
Fig, 6 |

VOLKMANN
33-476-01
33-476-10
17 cm, 6¾"



- | | | |
|---|--|---|
| 
33-778-01
Fig, 0000 | 
33-778-02
Fig, 000 | 
33-778-03
Fig, 00 |
| 
33-778-04
Fig, 0 | 
33-778-05
Fig, 1 | 
33-778-06
Fig, 2 |
| 
33-778-07
Fig, 3 | 
33-778-08
Fig, 4 | 
33-778-09
Fig, 5 |
| | | 
33-778-10
Fig, 6 |

BRUNS
33-778-01
33-778-10
17 cm, 6¾"



- | | | |
|---|--|--|
| 
33-479-01
Fig, 1 | 
33-479-02
Fig, 2 | 
33-479-03
Fig, 3 |
|---|--|--|

HALLE
33-479-01
33-479-03
21cm, 8¼"

Malleable
Biegsam
Maleable
Malleables
Malleabile



Bone Curettes
 Scharfe Löffel
 Cucharillas cortantes
 Curettes
 Curette per ossa

033



$\frac{1}{4}$
 33-480-01
 Fig. 000

$\frac{1}{4}$
 33-480-02
 Fig. 00

$\frac{1}{4}$
 33-480-03
 Fig. 0

$\frac{1}{4}$
 33-480-04
 Fig. 1

$\frac{1}{4}$
 33-480-05
 Fig. 2

$\frac{1}{4}$
 33-3480-06
 Fig. 3

$\frac{1}{4}$
 33-480-07
 Fig. 4

$\frac{1}{4}$
 33-480-08
 Fig. 5

$\frac{1}{4}$
 33-480-09
 Fig. 6



$\frac{1}{4}$
 33-481-01
 Fig. 000

$\frac{1}{4}$
 33-481-02
 Fig. 00

$\frac{1}{4}$
 33-481-03
 Fig. 0

$\frac{1}{4}$
 33-481-04
 Fig. 1

$\frac{1}{4}$
 33-481-05
 Fig. 2

$\frac{1}{4}$
 33-481-06
 Fig. 3

$\frac{1}{4}$
 33-481-07
 Fig. 4

$\frac{1}{4}$
 33-481-08
 Fig. 5

$\frac{1}{4}$
 33-481-09
 Fig. 6



$\frac{1}{2}$
BRUNS
 33-480-01
 33-481-09
 25 cm, 9 $\frac{1}{4}$ "



$\frac{1}{2}$
BRUNS
 33-484-01
 33-484-09
 23 cm, 9"

$\frac{1}{4}$
 33-484-01
 Fig. 000

$\frac{1}{4}$
 33-484-02
 Fig. 00

$\frac{1}{4}$
 33-484-03
 Fig. 0

$\frac{1}{4}$
 33-484-04
 Fig. 1

$\frac{1}{4}$
 33-484-05
 Fig. 2





$\frac{1}{4}$
 33-484-06
 Fig. 3





$\frac{1}{4}$
 33-484-07
 Fig. 4





$\frac{1}{4}$
 33-484-08
 Fig. 5

$\frac{1}{4}$
 33-484-09
 Fig. 6



 ¼ Fig. 000	 ¼ Fig. 00	 ¼ Fig. 0	 ¼ Fig. 1
33-486-01	33-485-02	33-485-03	33-485-04
33-485-01	33-486-02	33-486-03	33-486-04

 ¼ Fig. 000	 ¼ Fig. 00	 ¼ Fig. 0	 ¼ Fig. 1
33-487-01	33-487-02	33-487-03	33-487-04
33-488-01	33-488-02	33-488-03	33-488-04

 ¼ Fig. 000	 ¼ Fig. 00	 ¼ Fig. 0	 ¼ Fig. 1
33-489-01	33-489-02	33-489-03	33-489-04
33-490-01	33-490-02	33-490-03	33-490-04



sharp, rigid
 scharf, fest
 cortantes, rígidas
 tranchantes, rigides
 acute, rigide



33-485-01
 33-489-04
 25 cm, 10"

sharp, malleable
 scharf, biegsam
 cortantes, maleables
 tranchantes, malléables
 acute, malleabile

33-486-01
 33-490-04









 ¼ Fig. 00000	 ¼ Fig. 0000	 ¼ Fig. 000
33-492-01	33-492-02	33-492-03

 ¼ Fig. 00	 ¼ Fig. 0	 ¼ Fig. 1
33-492-04	33-492-05	33-492-06

LEMPERT
 33-492-01
 33-492-06
 17,5 cm, 7"





 ¼ Fig. 1	 ¼ Fig. 2	 ¼ Fig. 3
33-498-01	33-498-02	33-498-03

 ¼ Fig. 4	 ¼ Fig. 5	 ¼ Fig. 6
33-498-04	33-498-05	33-498-06

SIMON
 33-498-01
 33-498-06
 24 cm, 9½"



 ¼ Fig. 0000	 ¼ Fig. 00	 ¼ Fig. 00
33-494-01	33-494-02	33-494-03
2,8 mm	2,8 mm	3,6 mm
33-494-04	33-494-05	
4,4 mm	5,2 mm	
Fig. 0	Fig. 1	

DAUBENSPECK
 33-494-01
 33-494-05
 20 cm, 8"



Bone Curettes
Scharfe Löffel
Cucharillas cortantes
Curettes
Curette per ossa

Tampers
Stößel
Pisón
Chasse-Greffons
Punzoni



033

¼
33-500-01
Fig.0000

¼
33-500-02
Fig.000

¼
33-500-03
Fig.00

¼
33-500-04
Fig.0

¼
33-500-05
Fig.1

¼
33-500-06
Fig.2

¼
33-500-07
Fig.3

¼
33-500-08
Fig.4

¼
33-500-09
Fig.5

¼
33-500-10
Fig.6



VOLKMANN
33-500-01
33-500-10
17 cm, 6¾"

Bone Curettes with handle from artificial wood
Scharfe Löffel mit Ferrozellgriff
Cucharillas cortantes con mango de madera artificial
Curettes avec manche en " Ferrozell "

¼
33-504-01
Fig.0000

¼
33-504-02
Fig.000

¼
33-504-03
Fig.00

¼
33-504-04
Fig.0

¼
33-504-05
Fig.1

¼
33-504-06
Fig.2

¼
33-504-07
Fig.3

¼
33-504-08
Fig.4

¼
33-504-09
Fig.5

¼
33-504-10
Fig.6



VOLKMANN
33-504-01
33-504-10
27 cm, 10¼"

Bone Curettes with handle from artificial wood
Scharfe Löffel mit Ferrozellgriff
Cucharillas cortantes con mango de madera artificial
Curettes avec manche en " Ferrozell "

¼
33-504-01
Fig.0000

¼
33-504-02
Fig.000

¼
33-504-03
Fig.00

¼
33-504-04
Fig.0

¼
33-504-05
Fig.1

¼
33-504-06
Fig.2

¼
33-504-07
Fig.3

¼
33-504-08
Fig.4

¼
33-504-09
Fig.5

¼
33-504-10
Fig.6



33-560-03
33-560-16
20 cm, 8"

Tampers with handle from artificial wood
Stößel mit Ferrozellgriff
Pisón con mango de madera artificial
Chasse-Greffons avec manche en " Ferrozell "

¼
33-560-03
ø 3 mm

¼
33-560-05
ø 5 mm

¼
33-560-08
ø 8 mm

¼
33-560-12
ø 12 mm

¼
33-560-14
ø 14 mm

¼
33-560-16
ø 16 mm

¾
33-564-02
ø 2 mm

¾
33-564-03
ø 3 mm

¾
33-564-04
ø 4 mm

¾
33-564-05
ø 5 mm

¾
33-564-06
ø 6 mm

¾
33-564-08
ø 8 mm

¾
33-564-10
ø 10 mm



33-564-02
33-564-10
15,5 cm, 8"

Tampers
Stößel
Pisón
Chasse-Greffons
Punzoni

Can be autoclaved at 3 bar overpressure (143°C) !
Sterilisierbar im Autoklav bei 3 bar Überdruck (143°C) !
Esterilizables en autoclave a 3 bar sobrepresión (143°C) !
Stérilisables à l'autoclave à 3 bars (143°) !
Puo'essere autoclavato a 3 bar di pressione (143°) !



Chisels
 Flachmeißel
 Cinceles
 Ciseaux-burins
 Scalpelli

Gouges
 Hohlmeißel
 Gubias
 Gouges
 Sgorbie

Osteotomes
 Osteotome
 Osteótomos
 Ostéotomes
 Osteotomi



033

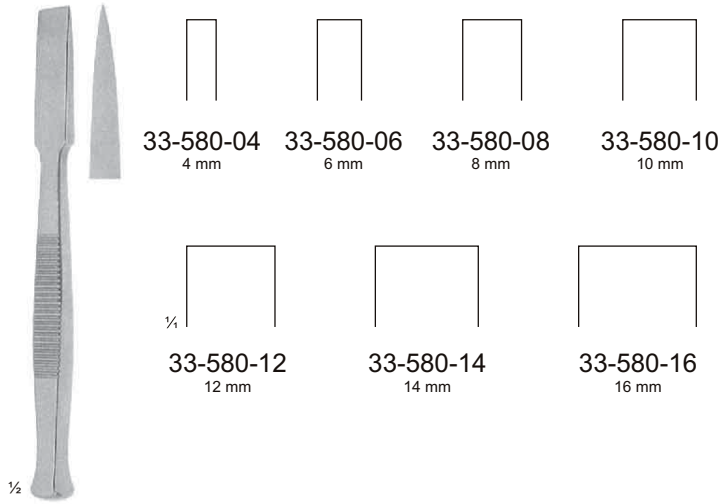

33-580-04 4 mm
 33-580-06 6 mm
 33-580-08 8 mm
 33-580-10 10 mm

33-580-12 12 mm
 33-580-14 14 mm
 33-580-16 16 mm

33-580-04
 33-580-16
 13,5 cm, 5/4"

Osteotomes
 Osteotome
 Osteótomos
 Ostéotomes
 Osteotomi

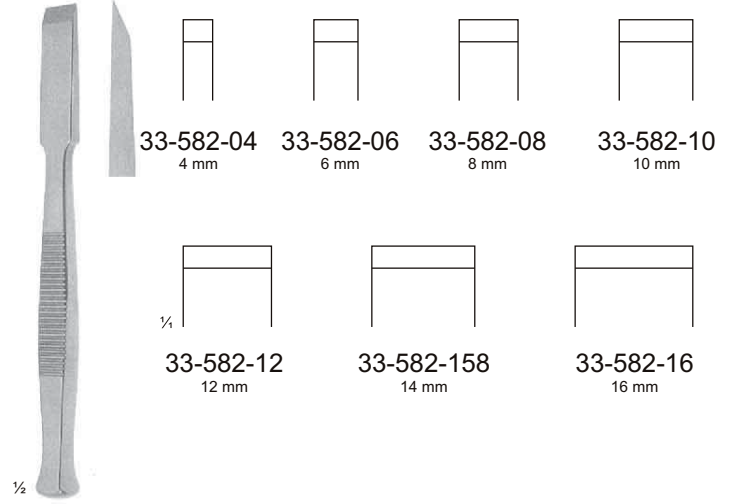

33-582-04 4 mm
 33-582-06 6 mm
 33-582-08 8 mm
 33-582-10 10 mm

33-582-12 12 mm
 33-582-158 14 mm
 33-582-16 16 mm

33-582-04
 33-582-16
 13,5 cm, 5/4"

Chisels
 Flachmeißel
 Cinceles
 Ciseaux-burins
 Scalpelli

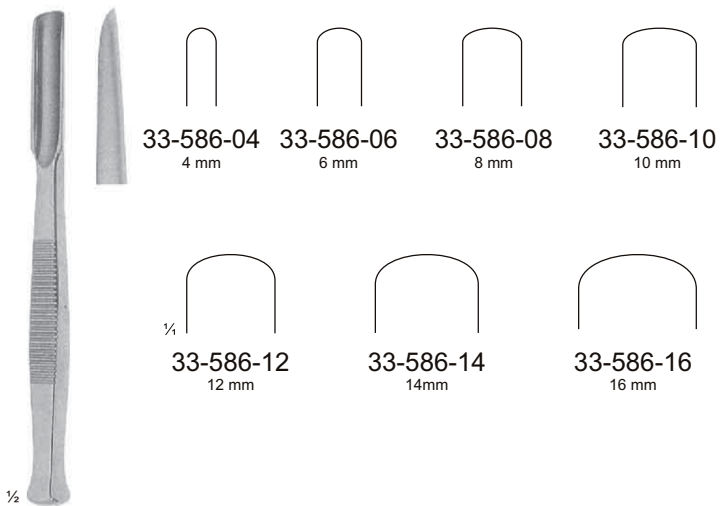

33-586-04 4 mm
 33-586-06 6 mm
 33-586-08 8 mm
 33-586-10 10 mm

33-586-12 12 mm
 33-586-14 14 mm
 33-586-16 16 mm

33-586-04
 33-586-16
 13,5 cm, 5/4"

Gouges
 Hohimeißel
 Gubias
 Gouges
 Sgorbie

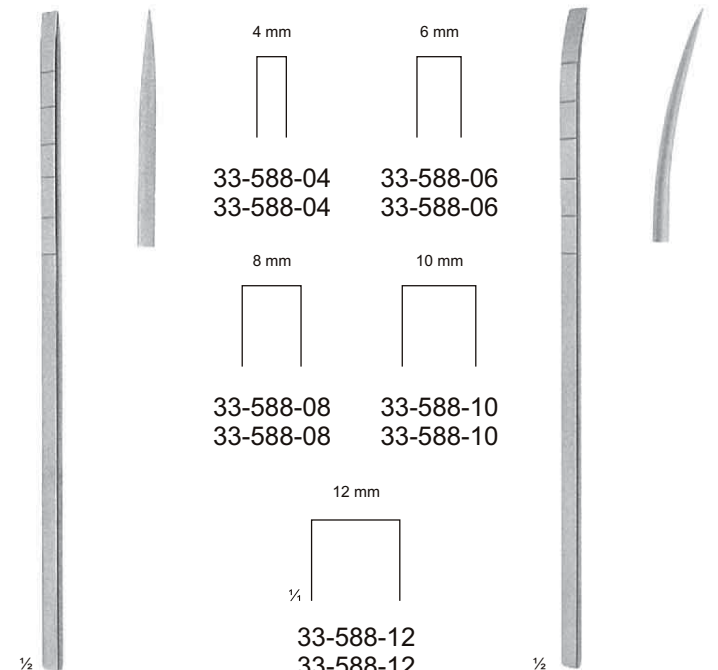

4 mm
 33-588-04
 33-588-04
 6 mm
 33-588-06
 33-588-06

8 mm
 33-588-08
 33-588-08
 10 mm
 33-588-10
 33-588-10

12 mm
 33-588-12
 33-588-12

COTTLE
 33-588-04
 33-588-12
 18 cm, 7"

With depth markings
 Mit Graduierung
 Graduado
 Graduado
 Graduado

COTTLE
 33-588-06
 33-588-12
 18 cm, 7"



Chisels
 Flachmeißel
 Cinceles
 Ciseaux-burins
 Scalpelli

Gouges
 Hohlmeißel
 Gubias
 Gouges
 Sgorbie

Osteotomes
 Osteotome
 Osteótomos
 Ostéotomes
 Osteotomi



033

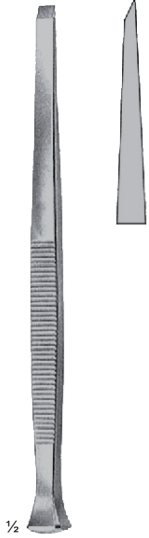

PARTSCH
 33-590-02
 33-592-06

33-590-02 13,5 cm, 5¼" 2 mm	33-590-03 13,5 cm, 5¼" 3 mm	33-590-04 13,5 cm, 5¼" 4 mm
33-590-05 13,5 cm, 5¼" 5 mm	33-590-06 13,5 cm, 5¼" 6 mm	
33-592-02 17 cm, 6¾" 2 mm	33-592-03 17 cm, 6¾" 3 mm	33-592-04 17 cm, 6¾" 4 mm
33-592-05 17 cm, 6¾" 5 mm	33-592-06 17 cm, 6¾" 6 mm	

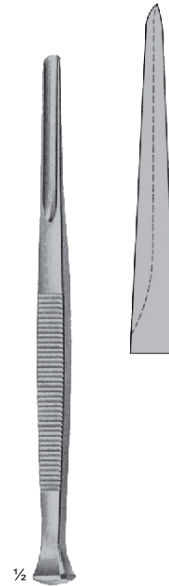

PARTSCH
 33-593-02
 33-595-06

33-593-02 13,5 cm, 5¼" 2 mm	33-593-03 13,5 cm, 5¼" 3 mm	33-593-04 13,5 cm, 5¼" 4 mm
33-593-05 13,5 cm, 5¼" 5 mm	33-593-06 13,5 cm, 5¼" 6 mm	
33-595-02 17 cm, 6¾" 2 mm	33-595-03 17 cm, 6¾" 3 mm	33-595-04 17 cm, 6¾" 4 mm
33-595-05 17 cm, 6¾" 5 mm	33-595-06 17 cm, 6¾" 6 mm	

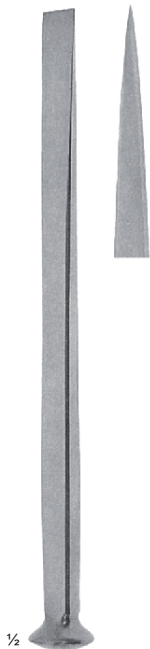

ALEXANDER
 33-596-04
 33-596-14
 18 cm, 7"

33-596-04 4 mm	33-596-06 6 mm
33-596-08 8 mm	33-596-10 10 mm
33-596-12 12 mm	33-596-14 14 mm

Osteotomes
 Osteotome
 Osteótomos
 Ostéotomes
 Osteotomi



ALEXANDER
 33-598-04
 33-598-14
 18 cm, 7"

33-598-04 4 mm	33-598-06 6 mm
33-598-08 8 mm	33-598-10 10 mm
33-598-12 12 mm	33-598-14 14 mm

Chisels
 Flachmeißel
 Cinceles
 Ciseaux-burins
 Scalpelli



ALEXANDER
 33-599-04
 33-599-14
 18 cm, 7"

33-599-04 4 mm	33-599-06 6 mm
33-599-08 8 mm	33-599-10 10 mm
33-599-12 12 mm	33-599-14 14 mm

Gouges
 Hohlmeißel
 Gubias
 Gouges
 Sgorbie



Chisels
 Flachmeißel
 Cinceles
 Ciseaux-burins
 Scalpelli

Gouges
 Hohlmeißel
 Gubias
 Gouges
 Sgorbie

Osteotomes
 Osteotome
 Osteótomos
 Ostéotomes
 Osteotomi



033

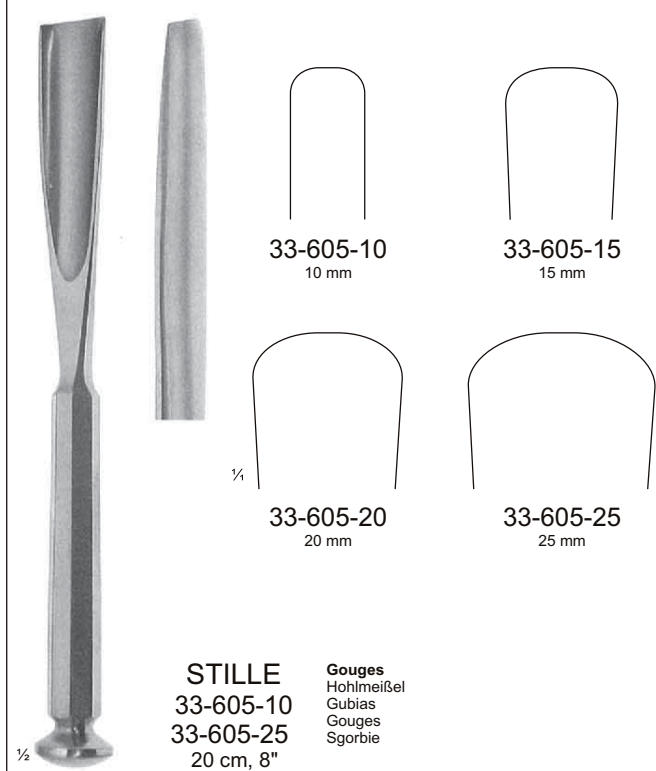
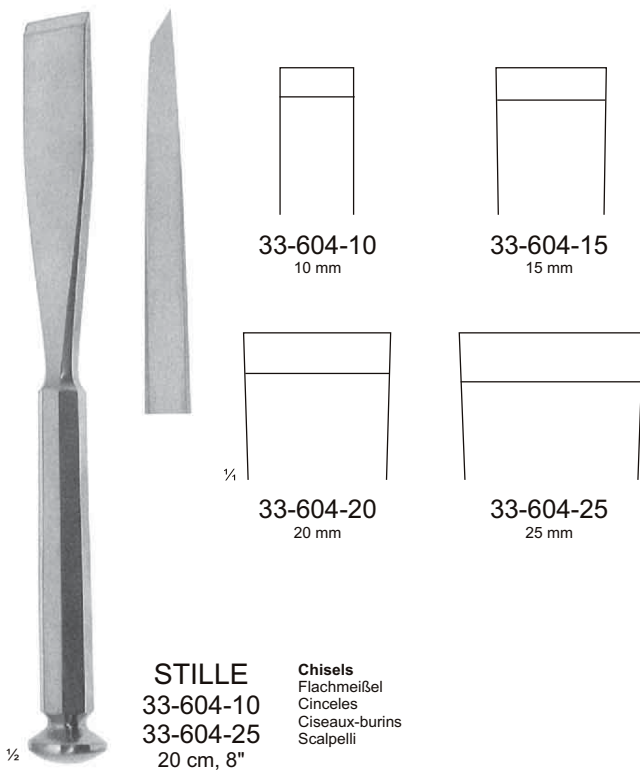
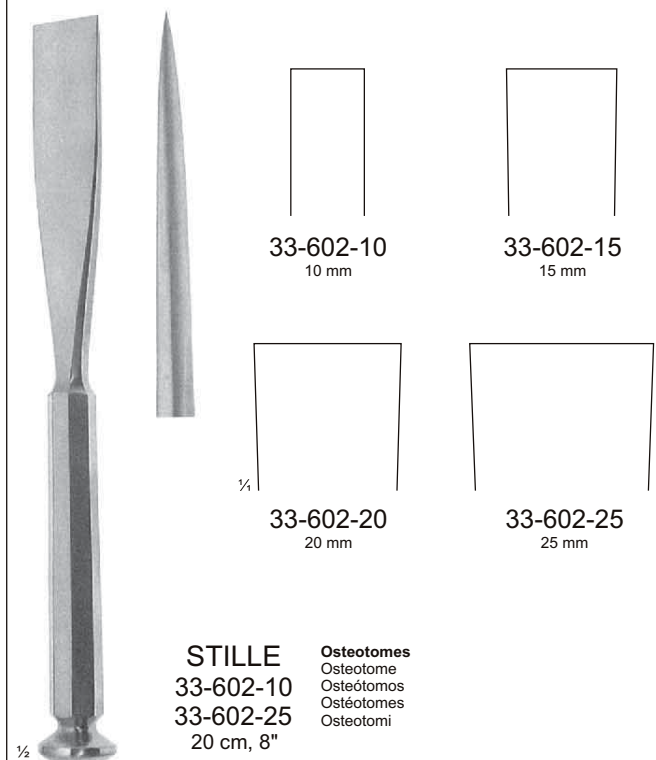
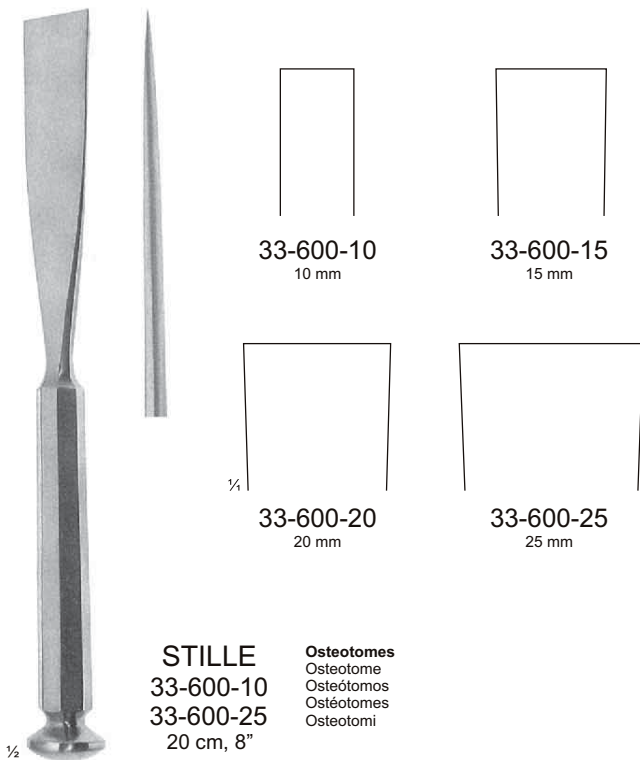



Osteotomes

Osteotomes
Osteótomos
Ostéotomes
Osteotomi



033

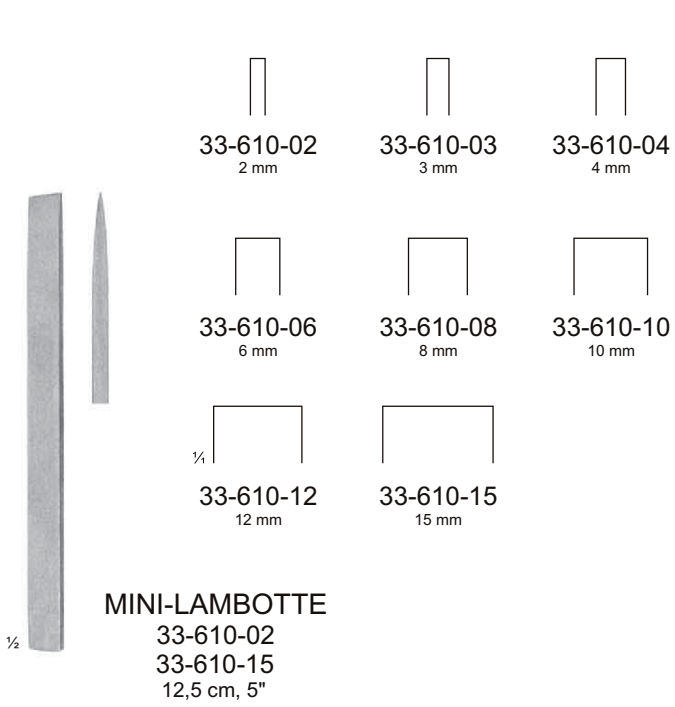

33-610-02
2 mm

33-610-03
3 mm

33-610-04
4 mm

33-610-06
6 mm

33-610-08
8 mm

33-610-10
10 mm

33-610-12
12 mm

33-610-15
15 mm

MINI-LAMBOTTE
33-610-02
33-610-15
12,5 cm, 5"

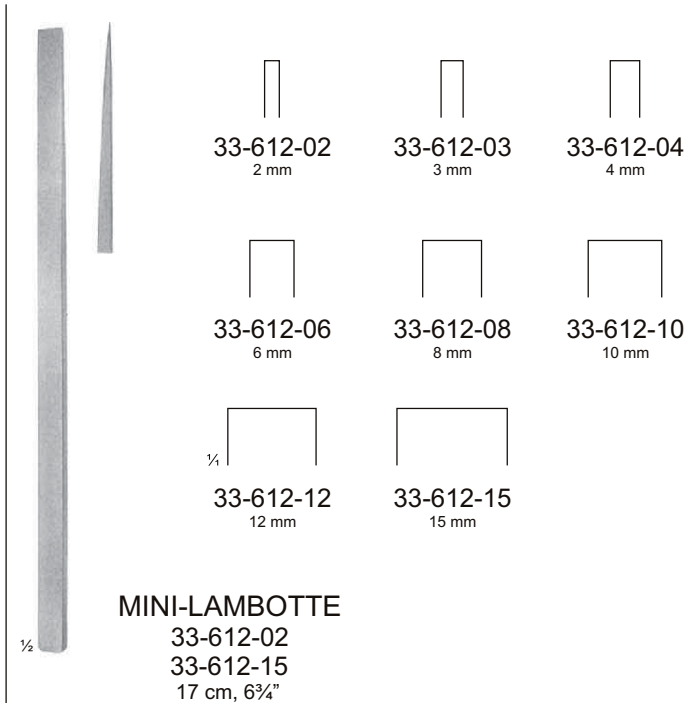

33-612-02
2 mm

33-612-03
3 mm

33-612-04
4 mm

33-612-06
6 mm

33-612-08
8 mm

33-612-10
10 mm

33-612-12
12 mm

33-612-15
15 mm

MINI-LAMBOTTE
33-612-02
33-612-15
17 cm, 6¾"

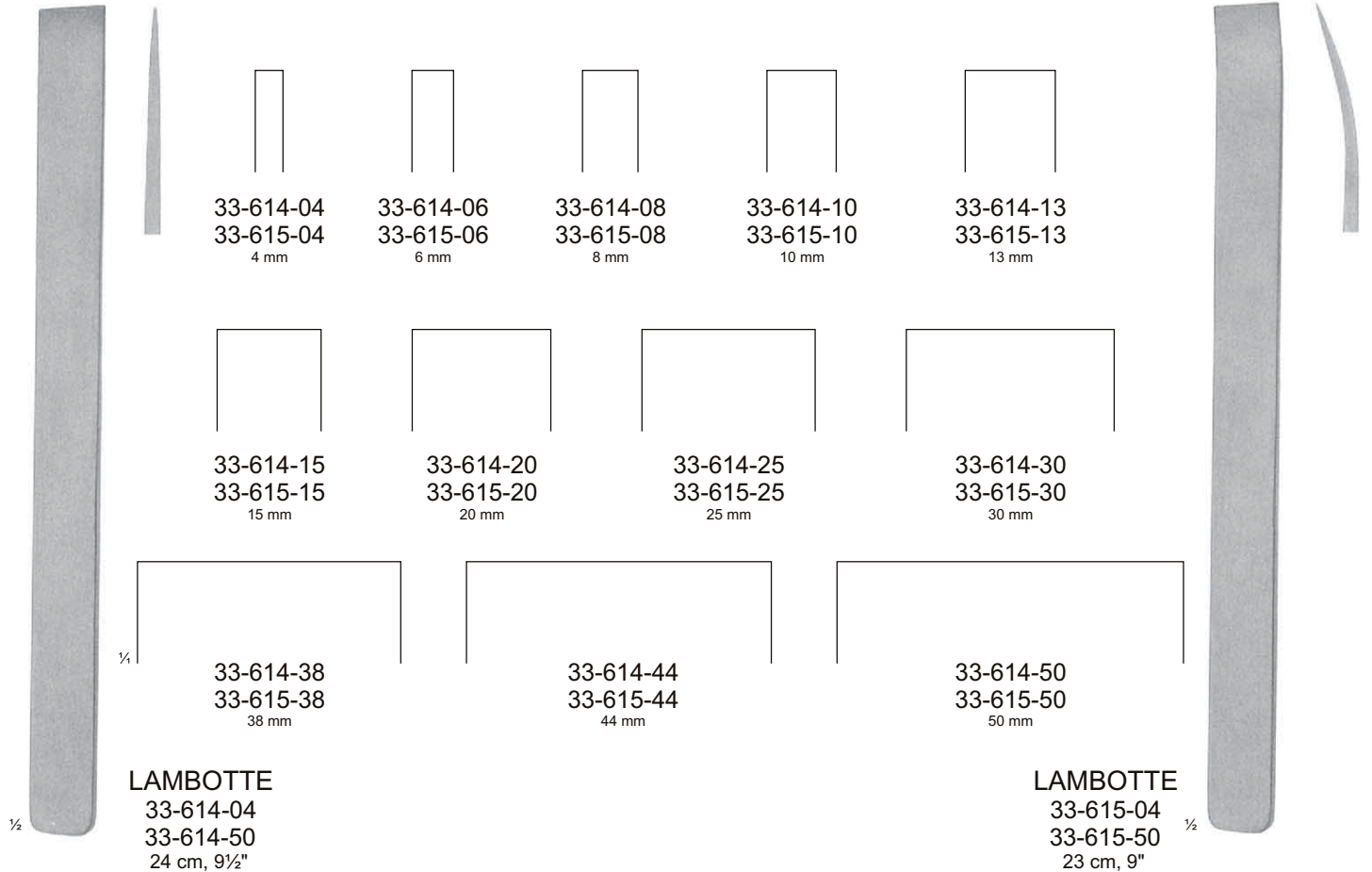

33-614-04
33-615-04
4 mm

33-614-06
33-615-06
6 mm

33-614-08
33-615-08
8 mm

33-614-10
33-615-10
10 mm

33-614-13
33-615-13
13 mm

33-614-15
33-615-15
15 mm

33-614-20
33-615-20
20 mm

33-614-25
33-615-25
25 mm

33-614-30
33-615-30
30 mm

33-614-38
33-615-38
38 mm

33-614-44
33-615-44
44 mm

33-614-50
33-615-50
50 mm

LAMBOTTE
33-614-04
33-614-50
24 cm, 9½"

LAMBOTTE
33-615-04
33-615-50
23 cm, 9"



Chisels
 Flachmeißel
 Cinceles
 Ciseaux-burins
 Scalpelli

Osteotomes
 Osteotome
 Osteótomos
 Ostéotomes
 Osteotomi



033

3 mm



33-620-01

5 mm



33-620-02

6 mm



33-620-03

8 mm



33-620-04

9 mm



33-620-05



HOKE
 33-620-01
 33-620-05
 17cm, 6¾"

6 mm



33-626-01

13 mm



33-626-02

19 mm

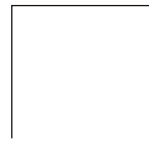

33-626-03

25 mm



33-626-04

32 mm



33-626-05

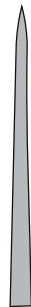

HIBBS
 33-626-01
 33-626-05
 24 cm, 9½"

6 mm



33-628-01

13 mm

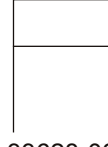

33628-02

19 mm

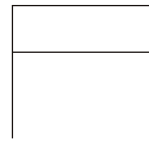

33-628-03

25 mm



33-628-04

32 mm

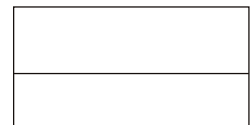

33-628-05



HIBBS
 33-628-01
33-626-05
 24 cm, 9½"

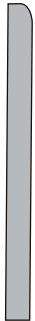

33-633-01
9 mm



33-633-02
14 mm



33-633-03
19 mm

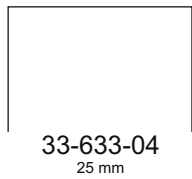

33-633-04
25 mm

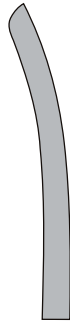

33-635-01
9 mm



33-635-02
14 mm

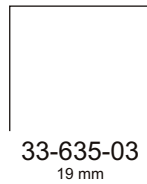

33-635-03
19 mm

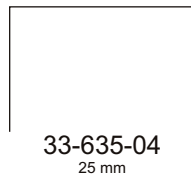

33-635-04
25 mm



33-634-01
6 mm



33-634-02
9 mm



33-634-03
13 mm



33-634-04
16 mm

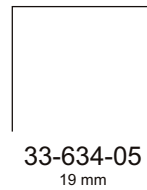

33-634-05
19 mm

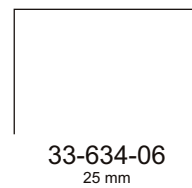

33-634-06
25 mm

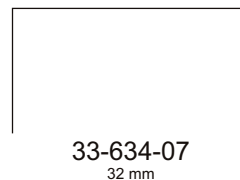

33-634-07
32 mm

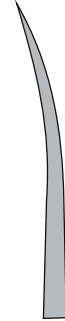

33-636-01
6 mm



33-636-02
9 mm



33-636-03
13 mm



33-636-04
16 mm



33-636-05
19 mm

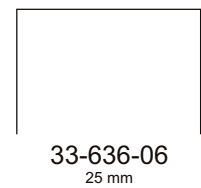

33-636-06
25 mm



33-636-07
32 mm

33-633-01
33-633-04
20 cm, 8"

33-635-01
33-635-04
20 cm, 8"

33-634-01
33-634-07
20 cm, 8"

33-636-01
33-636-07
20 cm, 8"



Osteotomes

Osteotomes
Osteótomos
Ostéotomes
Osteotomi

Gouges

Hohlmeißel
Gubias
Gouges
Sgorbie



033

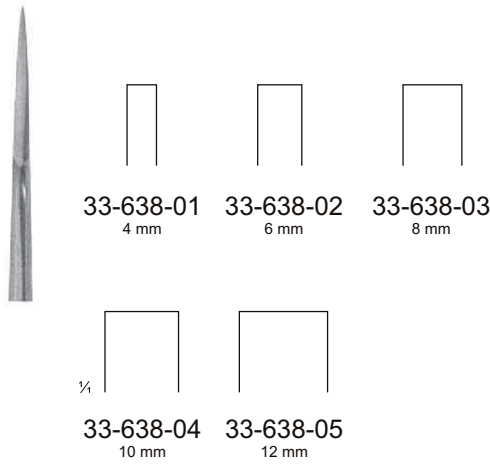

MINI-LEXER
33-638-01
33-638-05
18 cm, 7"

Osteotomes
Osteotomes
Osteótomos
Ostéotomes
Osteotomi



MINI-LEXER
33-639-01
33-639-05
18 cm, 7"

Gouges
Hohlmeißel
Gubias
Gouges
Sgorbie

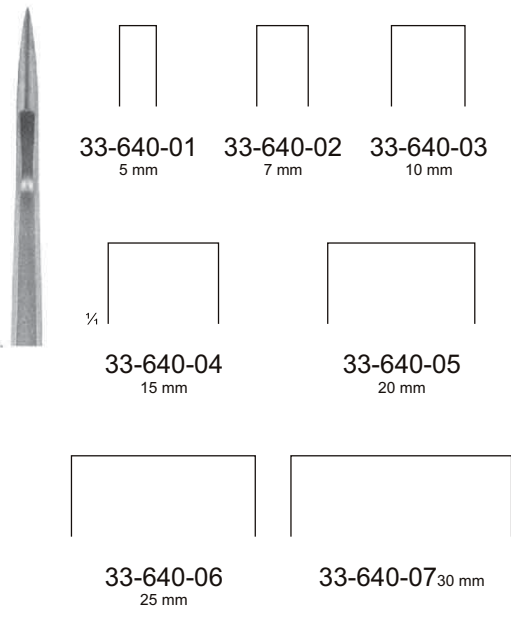

LEXER
33-640-01
33-640-07
23 cm, 8 3/4"

Osteotomes
Osteotomes
Osteótomos
Ostéotomes
Osteotomi

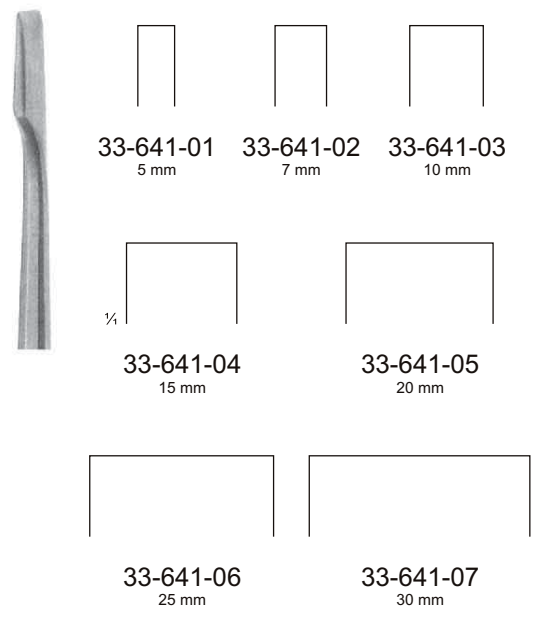

LEXER
33-641-01
33-641-07
22 cm, 8 3/4"

Gouges
Hohlmeißel
Gubias
Gouges
Sgorbie

Osteotomes, Gouges and Chisels with handle from artificial wood

Osteotomes, Hohlmeißel und Flachmeißel mit Ferrozellgriff
 Osteótomos, gubias y cinceles con mango de madera artificial
 Ostéotomes, gouges et ciseaux-burins avec manche en " Ferrozell "
 Osteotomi, sgorbie e scalpelli con manico in legno artificiale

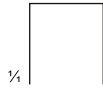
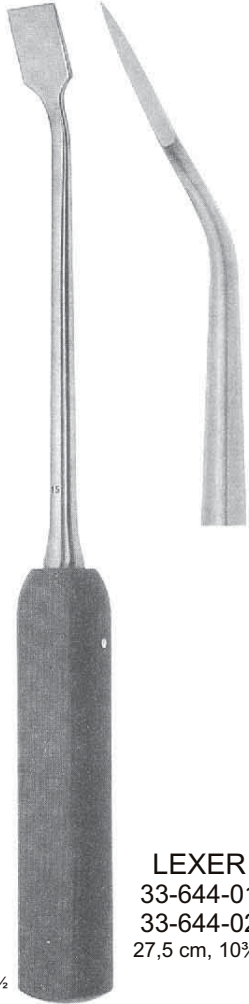

33-644-01
 33-645-01
 10 mm



33-644-02
 33-645-02
 15 mm

LEXER
 33-644-01
 33-644-02
 27,5 cm, 10 3/4"

Gouges, angled
 Hohlmeißel, abgewinkelt
 Gubias, acodadas
 Gouges, angulées
 Sgorbie, angolati

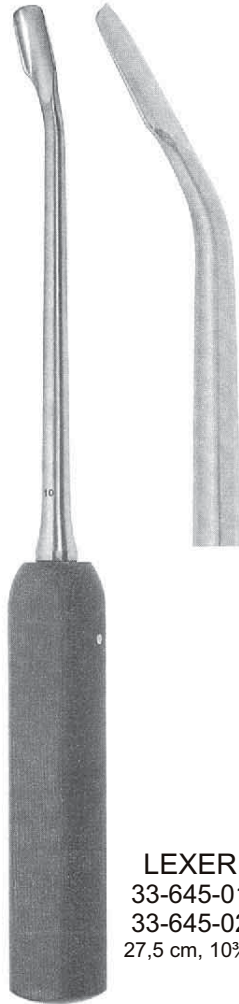

LEXER
 33-645-01
 33-645-02
 27,5 cm, 10 3/4"

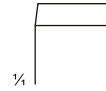

33-648-01
 10 mm

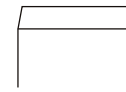

33-648-02
 15 mm

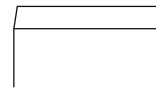

33-648-03
 20 mm

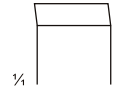

33-650-01
 10 mm

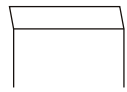

33-650-02
 15 mm

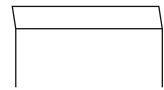

33-650-03
 20 mm

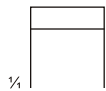
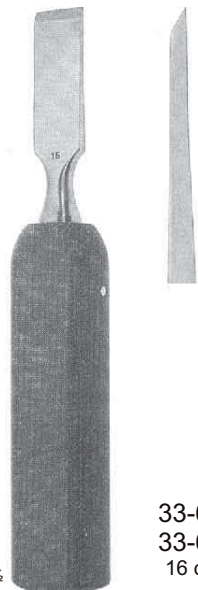

33-646-01
 10 mm

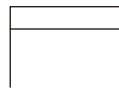

33-646-02
 15 mm

33-646-01
 33-646-02
 16 cm, 6 1/4"

Chisels
 Flachmeißel
 Cinceles
 Ciseaux-burins
 Scalpelli



33-648-01
 33-648-03
 20 cm, 8"

Chisels
 Flachmeißel
 Cinceles
 Ciseaux-burins
 Scalpelli



33-650-01
 33-650-03
 20 cm, 8"

Chisels
 Flachmeißel
 Cinceles
 Ciseaux-burins
 Scalpelli



Gouges with handle form artificial wood

Hohlmeißel mit Ferrozellgriff
Gubias con mango de madera artificial
Gouges avec manche en " Ferrozell "
Sgorbie con manico in legno artificiale



033

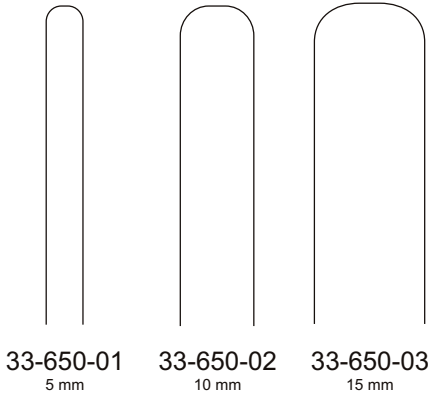

LEXER
33-650-01
33-650-03
25 cm, 10"

Spongiosa gouges
Spongiosa-Hohlmeißel
Gubias de esponjosa
Ciseaux-burins spongiose
Sgorbie per tessuto osseo spugnoso

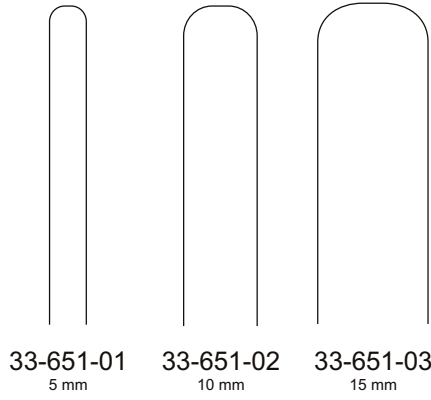

LEXER
33-651-01
33-651-03
25 cm, 10"

Spongiosa gouges
Spongiosa-Hohlmeißel
Gubias de esponjosa
Ciseaux-burins spongiose
Sgorbie per tessuto osseo spugnoso

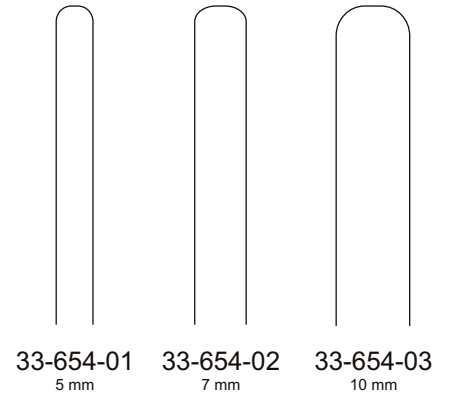

LEXER
33-654-01
33-654-03
28 cm, 11"

Spongiosa gouges
Spongiosa-Hohlmeißel
Gubias de esponjosa
Ciseaux-burins spongiose
Sgorbie per tessuto osseo spugnoso



Gouges with handle form artificial wood
Hohlmeißel mit Ferrozellgriff
Gubias con mango de madera artificial
Gouges avec manche en " Ferrozell "
Sgorbie con manico in legno artificiale



033



8 mm

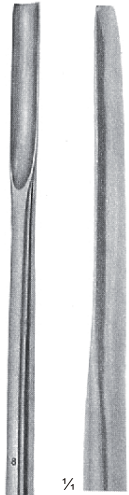

1/2

COBB
33-658-28
28 cm, 11"

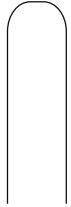

8 mm



1/2

COBB
33-659-28
28 cm, 11"



8 mm

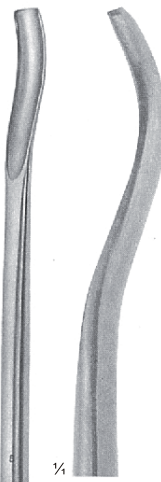

1/2

COBB
33-661-28
28 cm, 11"



8 mm

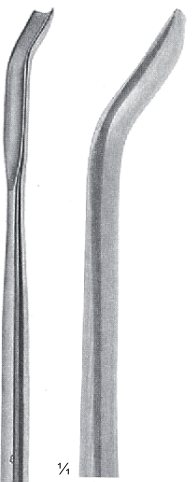

1/2

COBB
33-663-28
28 cm, 11"

Spinal gouge,
Spinal-Hohlmeißel,
Gubia espinal,
Gouge spinale,
Sgorbie spinali,

033



Bone Surgery
Knochenchirurgie
Cirugía ósea
Chirurgie osseuse
Chirurgia ossea



Ø 20 mm
140 g



33-670-10 100 g
 33-670-14 140 g
 16,5 cm, 6½"

Ø 26 mm
320 g

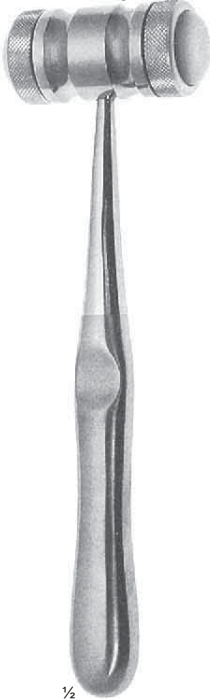

MEAD
 33-672-17 185 g
 17 cm, 6¾"

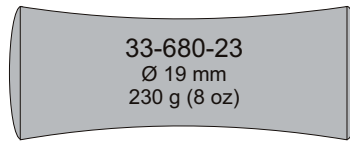

33-680-23
 Ø 19 mm
 230 g (8 oz)

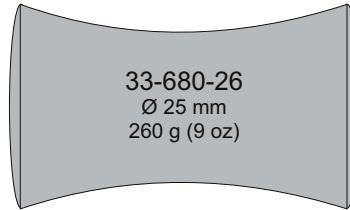

33-680-26
 Ø 25 mm
 260 g (9 oz)

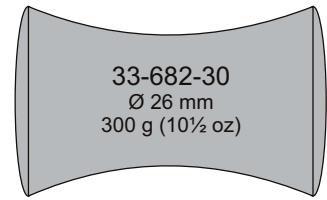

33-682-30
 Ø 26 mm
 300 g (10½ oz)

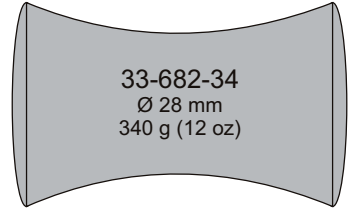

33-682-34
 Ø 28 mm
 340 g (12 oz)

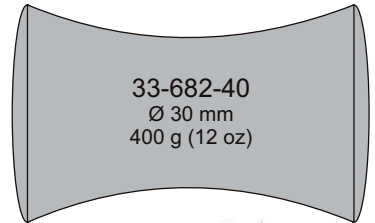

33-682-40
 Ø 30 mm
 400 g (12 oz)

Ø 22 mm
165 g



33-676-19 165 g
 19 cm, 7½"



Ø 30 mm
220 g

COLLIN
 33-678-20 220 g
 20 cm, 8"



LUCAE
 33-680-23
 33-680-26
 19 cm, 7½"



WILLIGER
 33-682-30
 33-682-40
 24 cm, 9½"

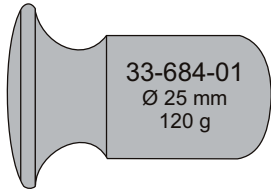

33-684-01
 Ø 25 mm
 120 g

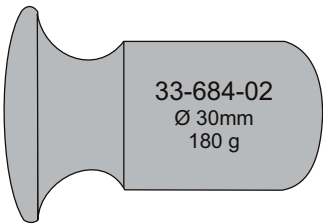

33-684-02
 Ø 30mm
 180 g

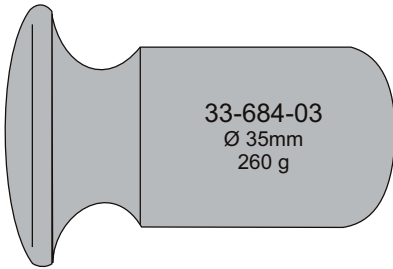

33-684-03
 Ø 35mm
 260 g

Ø 25 mm



GERZOG
 33-686-25
 19 cm, 7½"
 210 g

½

Ø 27 mm



HAJEK
 33-690-27
 20 cm, 8"
 140 g

½



DOYEN
 33-684-01
 33-684-03
 21 cm, 8¼"

½

Ø 40 mm



KIRIK
 33-688-40
 21 cm, 8¼"
 700 g

½

Ø 20 mm



HAJEK
 33-692-20
 21,5 cm, 8½"
 110 g

½



PARTSCH
 33-694-22
 18 cm, 7"
 200 g



VICKERS
 33-700-22
 19 cm 7¾"

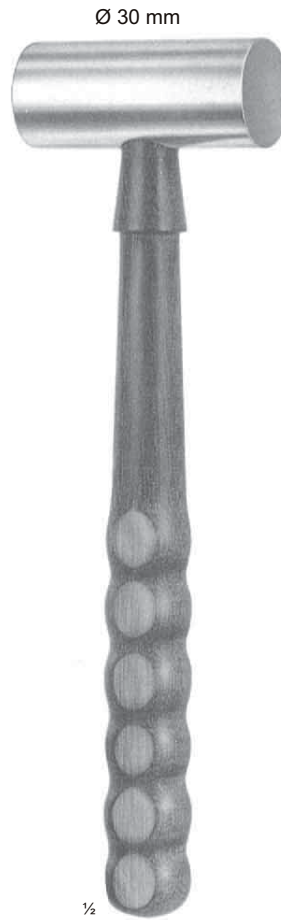

33-702-30
 24 cm, 9½"
 480 g



33-704-30
 26 cm 10½"
 510 g



½

33-706-00
 26 cm, 10½"
 450 g



½

33-708-01
 24 cm, 9½"
 390 g Ø 32 mm

33-708-02
 24 cm, 9½"
 540 g Ø 35 mm

33-708-03
 24 cm, 9½"
 740 g Ø 40 mm

Ø 42 mm Ø 30 mm



½

33-710-00
 26 cm, 10½"
 530 g

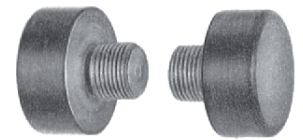

33-712-01

Ø 37 mm

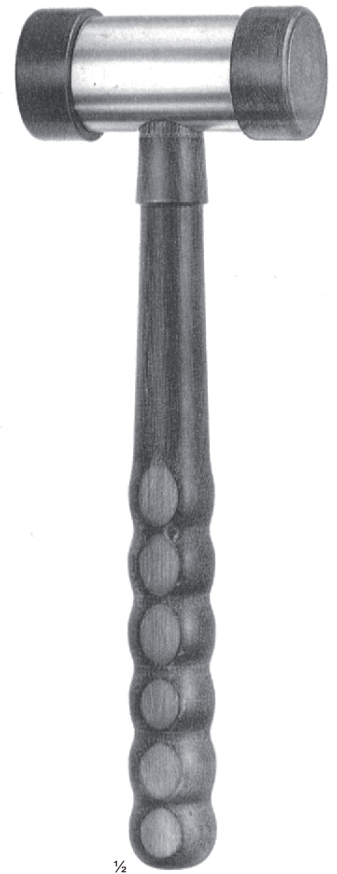

½

33-712-37
 22,5 cm, 9"
 370 g



½

33-714-00
 26,5 cm, 10½"



½

33-716-00
 25 cm, 10"
 215 g Ø 30 mm

With interchangeable plastic disk
 Mit auswechselbaren Kunststoffbacken
 Con tapas de plástico intercambiables
 Avec masse plastique interchangeable
 Con piastre di plastica intercambiabili



½

33-718-00
 26,5 cm, 10½"
 900 g



Ø 30 mm

½

33-720-30
 18 cm, 7"
 125 g



Ø 42 mm

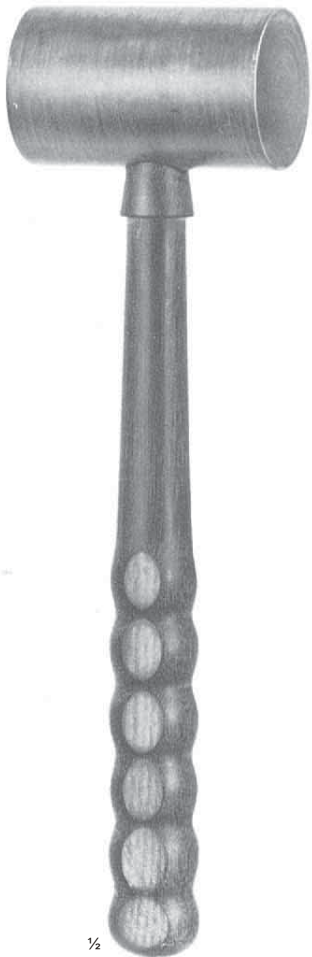

½

33-722-00 250 g
33-722-01 400 g
26 cm 10¼"

Ø 42 mm

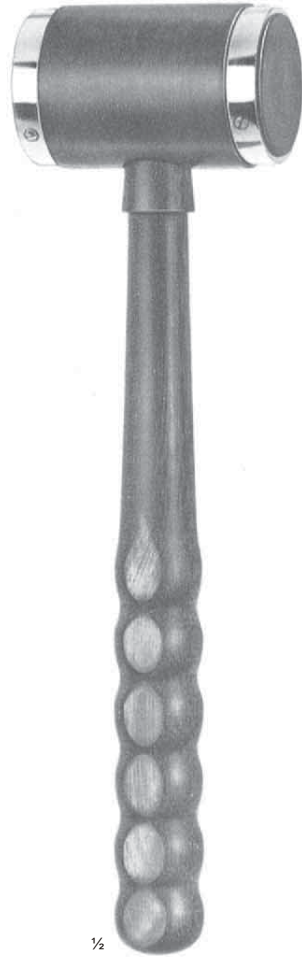

½

33-724-25
26 cm 10¼"
250 g

Ø 25 mm

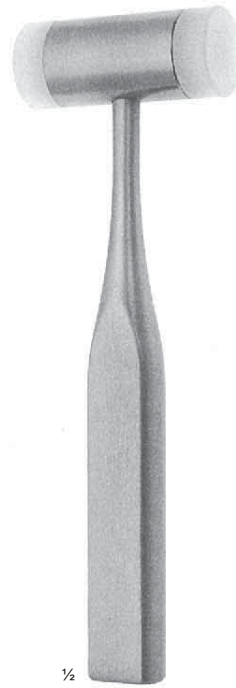

½

33-730-25
18,5 cm, 7¼"
140 g

With interchangeable plastic disk
Mit auswechselbaren Kunststoffbacken
Con tapas de plástico intercambiables
Avec masse plastique interchangeable
Con piastra di plastica intercambiabili

33-620-01



33-620-02



33-620-03



Ø 35 mm



½

WAGNER
33-732-00 170 g
33-732-01 260 g
23,5 cm, 9¼"

With interchangeable plastic disk
Mit auswechselbaren Kunststoffbacken
Con tapas de plástico intercambiables
Avec masse plastique interchangeable
Con piastra di plastica intercambiabili



Ø 30 mm



1/2

BERGMANN
 33-734-30
 23,5 cm, 9 1/4"
 300 g

Ø 45 mm



1/2

BERGMANN
 33-736-45
 25 cm, 10"
 300 g

Ø 29/42 mm



1/2

BERGMANN
 33-738-00
 25 cm, 10"
 300 g

Ø 40 mm

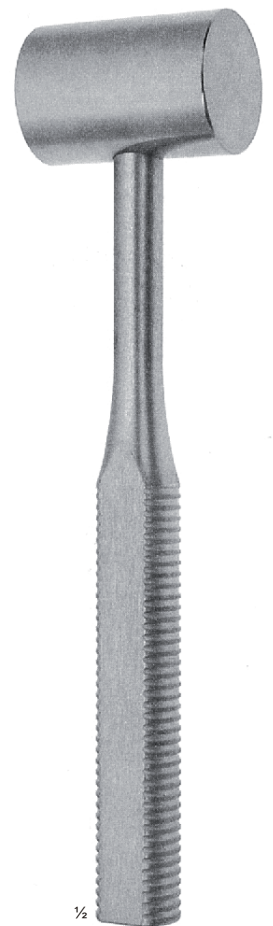

1/2

OMBREDANNE
 33-740-40
 25 cm, 10"
 550 g



Meniscus Knives
 Meniskusmesser
 Bisturies para menisco
 Bistouris à ménisque
 Bisturi pe menisco

Retractors for knee
 Wund-und Meniskushaken
 Separadores para rodilla
 Ecarteurs pour genou
 Retrattori per ginocchio



033



33-750-01
 19 cm, 7½"



33-750-02
 19 cm, 7½"



BIRCHER
 33-750-01
 33-750-02



33-752-01
 17 cm, 6¾"



33-752-02
 17 cm, 6¾"

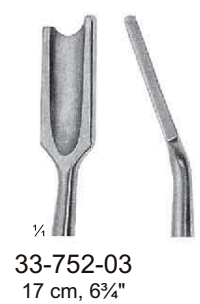

33-752-03
 17 cm, 6¾"

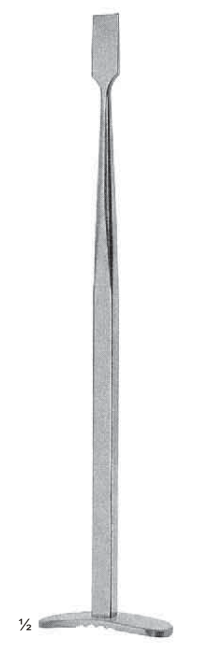

SMILLIE
 33-752-01
 33-752-03



33-753-01
 20,5 cm, 8"



33-753-02
 20,5 cm, 8"



CANAD MODELL
 33-753-01
 33-753-02

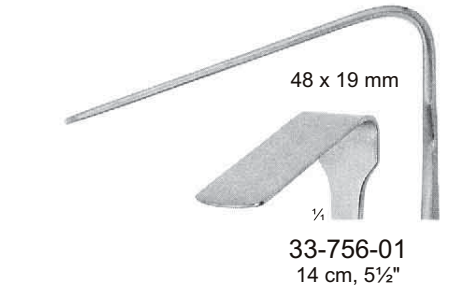

48 x 19 mm

33-756-01
 14 cm, 5½"

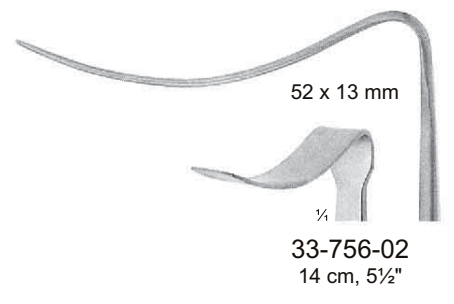

52 x 13 mm

33-756-02
 14 cm, 5½"

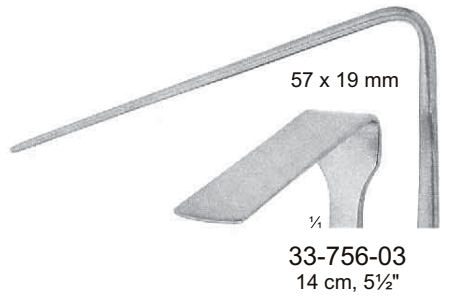

57 x 19 mm

33-756-03
 14 cm, 5½"

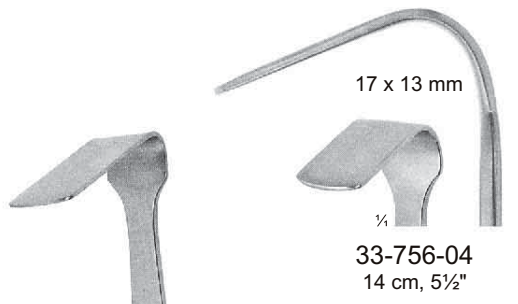

17 x 13 mm

33-756-04
 14 cm, 5½"

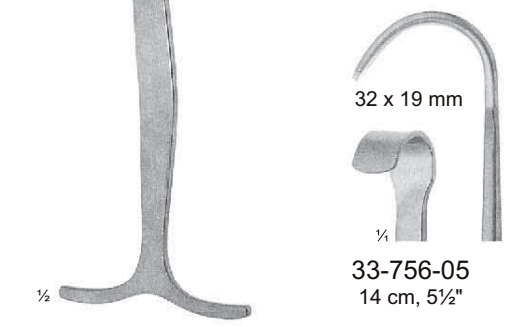

32 x 19 mm

33-756-05
 14 cm, 5½"

SMILLIE
 33-756-01
 33-756-05



Meniscus Knives
Meniskusmesser
Bisturías para menisco
Bistouris à ménisque
Bisturi pe menisco



033

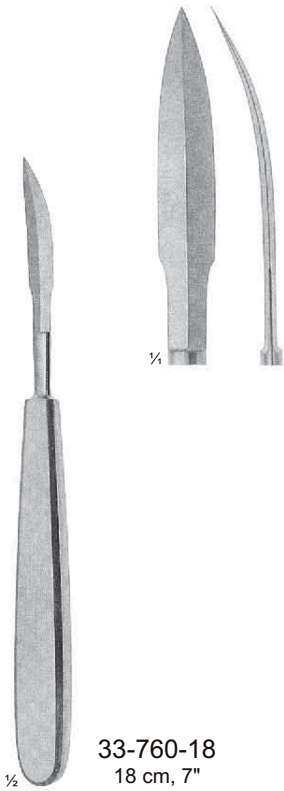

33-760-18
18 cm, 7"



33-762-01
22 cm, 8 3/4"



NEFF
33-762-01
33-762-02

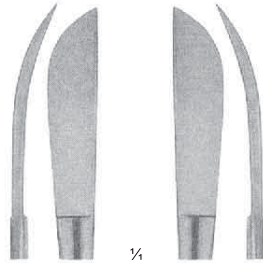

33-762-02
22 cm, 8 3/4"



33-764-01
22 cm, 8 3/4"

SALENIUS
33-764-01
33-764-02

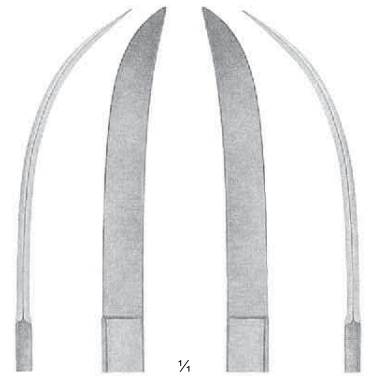

33-764-02
22 cm, 8 3/4"



VICKERS
33-765-24 25 cm, 10"
33-765-37 37 cm, 14 1/2"

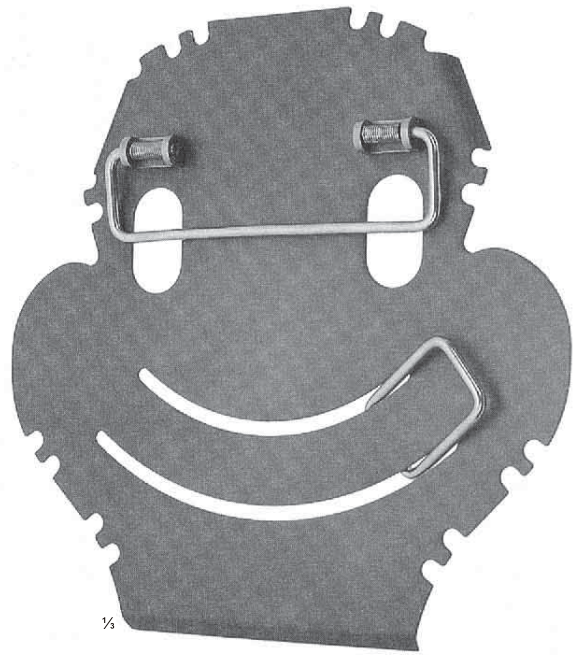

VICKERS
33-767-25
25 cm, 10"

33-776-15
15 cm, 6"



33-777-15
15 cm, 6"



33-778-20
20,5 cm, 8"

33-776-19
19 cm, 7½"



33-777-19
19 cm, 7½"



33-789-20
20,5 cm, 8"



33-776-24
24 cm, 9½"



33-777-24
24 cm, 9½"

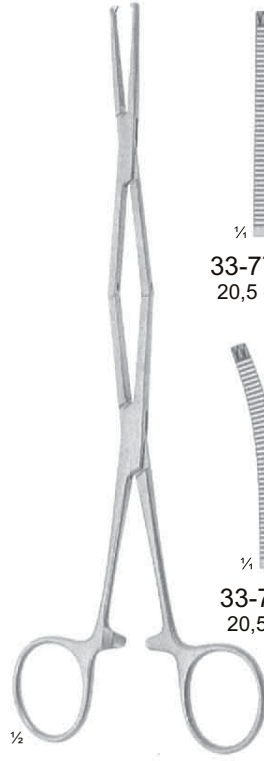
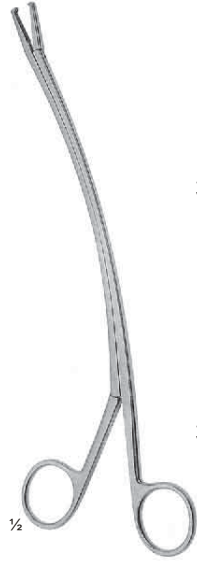

BRAND
33-776-15
33-776-24

BRAND
33-777-15
33-777-24

33-778-20
33-789-20

KLEINERT-KUTZ
33-781-20
20 cm, 8"



33-782-15
15 cm, 6"

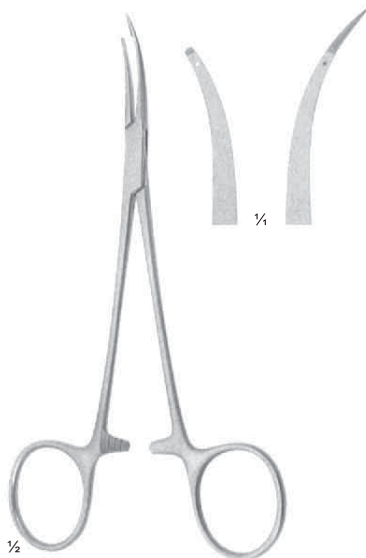

33-783-15
15 cm, 6"

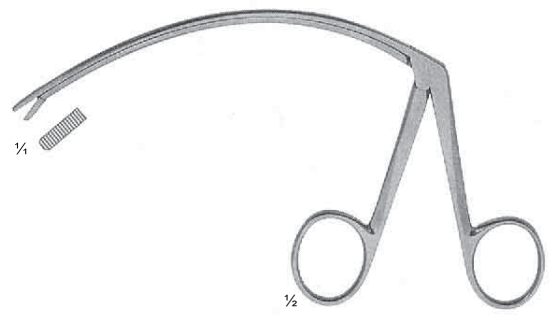

Working length: 11 cm, 4¾"
 Nutzlänge: 11 cm, 4¾"
 Longitud útil: 11 cm, 4¾"
 Longueur utile: 11 cm, 4¾"
 Lunghezza di lavoro: 11 cm, 4¾"

CARROLL
33-785-11
11 cm, 9"

Tendon Passing Instruments

Sehnenführer
 Conductor de tendones
 Conducteurs à tendons
 Guida per tendine

33-776-15
 15 cm, 6"



33-777-15
 15 cm, 6"



33-778-20
 20,5 cm, 8"

33-776-19
 19 cm, 7½"



33-777-19
 19 cm, 7½"



33-789-20
 20,5 cm, 8"



33-776-24
 24 cm, 9½"



33-777-24
 24 cm, 9½"



BRAND
 33-776-15
 33-776-24

BRAND
 33-777-15
 33-777-24

33-778-20
 33-789-20

KLEINERT-KUTZ
 33-781-20
 20 cm, 8"



33-782-15
 15 cm, 6"



33-783-15
 15 cm, 6"

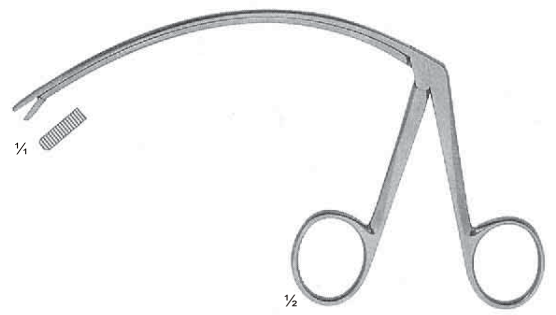

Working length: 11 cm, 4¾"
 Nutzlänge: 11 cm, 4¾"
 Longitud útil: 11 cm, 4¾"
 Longueur utile: 11 cm, 4¾"
 Lunghezza di lavoro: 11 cm, 4¾"

CARROLL
 33-785-11
 11 cm, 9"



33-790-14
 14 cm, 5½"



33-791-13
 13,5 cm, 5¼"

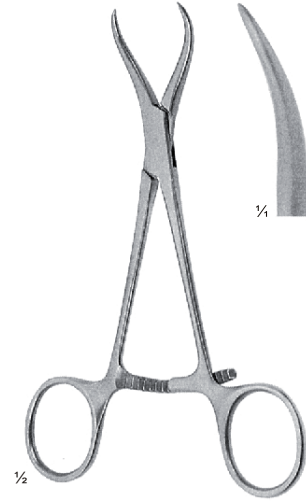

33-792-13
 13,5 cm, 5¼"



LEWIN
 33-794-17
 17,5 cm, 7"



33-796-20
 20 cm, 8"

Meniscus and Cartilage Grasping Forceps

Meniskus- und Knorpelfaßzangen

Pinzas para menisco y cartilago

Pinces à ménisque et cartilage

Pinze da presa per menisco e cartillagine



033

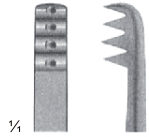

33-798-16
16,5 cm, 6½"

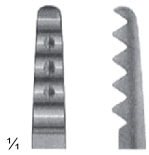

33-798-19
19 cm, 7½"

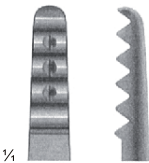

33-798-20
20 cm, 8"

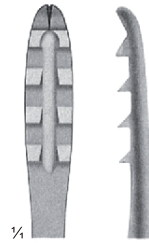

33-800-20
20 cm, 8"

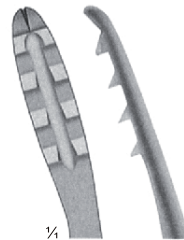

33-801-20
20 cm, 8"

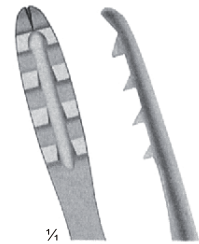

MARTIN
33-798-16
33-798-20



BIRCHER-GANSKE
33-800-20
33-801-20



BIRCHER-GANSKE
33-803-20
20 cm, 8"



Reposition forceps
 Repositionszangen
 Pinzas para reducción
 Pinces à réduction
 Pinze per riposizioni

Bone Holding Forceps
 Knochenhalte-zangen
 Pinzas para huesos
 Daviers
 Tenaglie per ossa



033

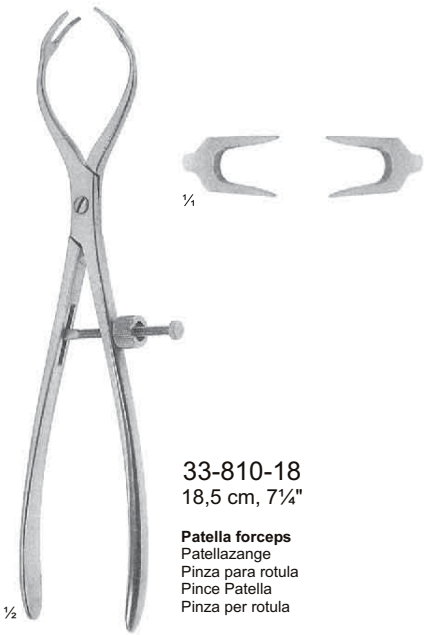

33-810-18
 18,5 cm, 7 1/4"

Patella forceps
 Patellazange
 Pinza para rotula
 Pince Patella
 Pinza per rotula

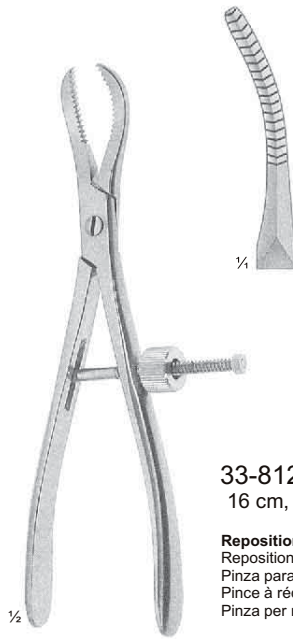

33-812-16
 16 cm, 6 1/4"

Reposition forceps
 Repositionszange
 Pinza para reducción
 Pince à réduction
 Pinza per riposizioni

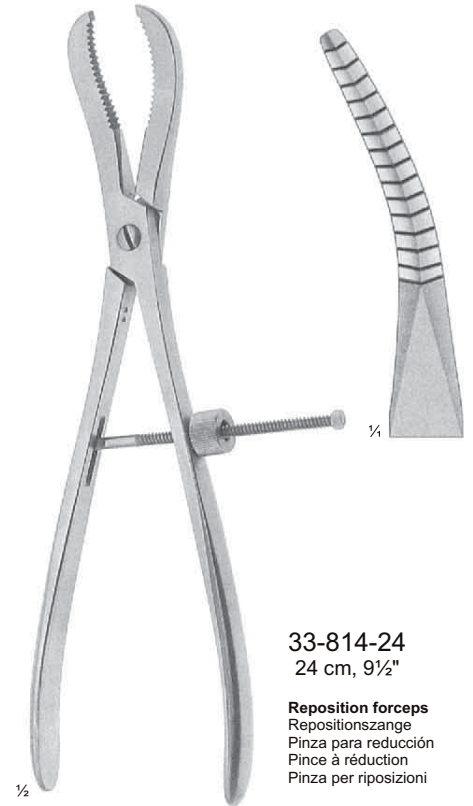

33-814-24
 24 cm, 9 1/2"

Reposition forceps
 Repositionszange
 Pinza para reducción
 Pince à réduction
 Pinza per riposizioni

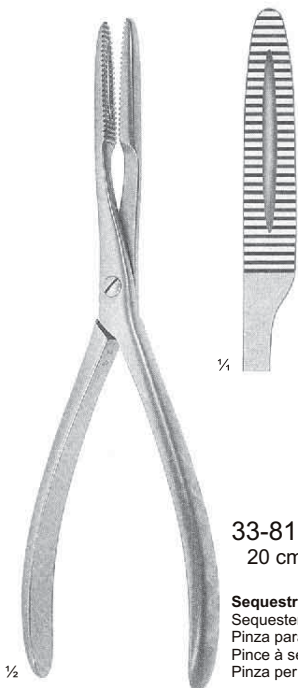

33-816-20
 20 cm, 8"

Sequesterum forceps
 Sequesterzange
 Pinza para secuestro
 Pince à séquestre
 Pinza per frammento osseo



33-817-20
 20 cm, 8"

Sequesterum forceps
 Sequesterzange
 Pinza para secuestro
 Pince à séquestre
 Pinza per frammento osseo

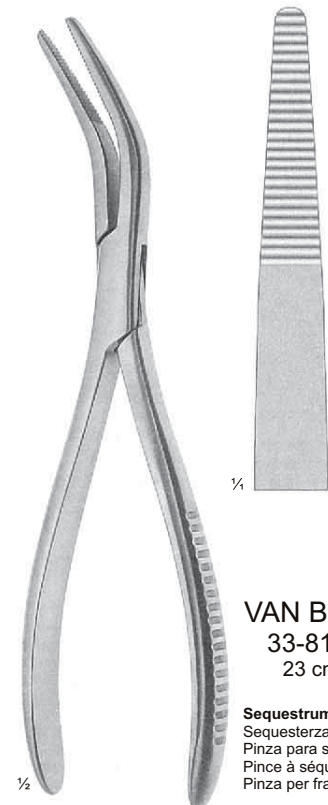

VAN BRUEN
33-819-23
 23 cm, 9"

Sequesterum forceps
 Sequesterzange
 Pinza para secuestro
 Pince à séquestre
 Pinza per frammento osseo



Bone Holding Forceps
Knochenhalte­zangen
Pinzas para huesos
Daviers
Tenaglie per ossa



033



33-820-20
20 cm, 8"



LANGENBECK
33-822-21
21 cm, 8¼"

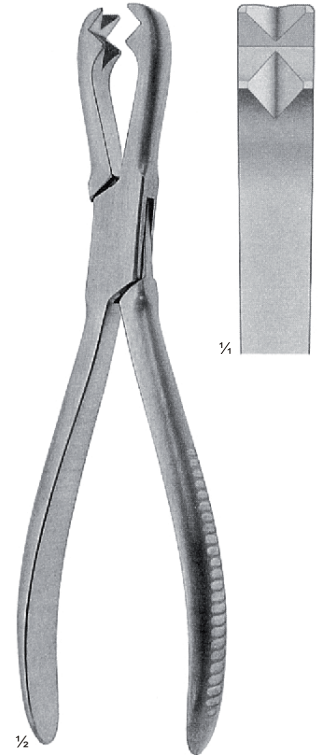

FERGUSON
33-824-20
20 cm, 8¼"



DINGMANN
33-825-19
19 cm, 7½"



DINGMANN
33-827-18
18,5 cm, 7¼"



1/2

SEM B
 33-839-19
 19 cm, 7 1/2"

Rib and bone holding forceps
 Rippen- und Knochenfalszange
 Pinza para huesos
 Daviers à os
 Pinza per ossa e costole



1/2

SEM B
 33-841-19 19 cm, 7 3/4"
 33-850-17 17 cm, 6 3/4"
 33-850-23 23 cm, 9"

Rib and bone holding forceps
 Rippen- und Knochenfalszange
 Pinza para huesos
 Daviers à os
 Pinza per ossa e costole



1/2

FARABEUF
 33-860-23 23 cm, 9"
 33-860-26 26 cm, 10 1/4"

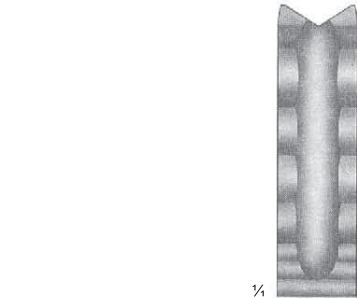

1/4

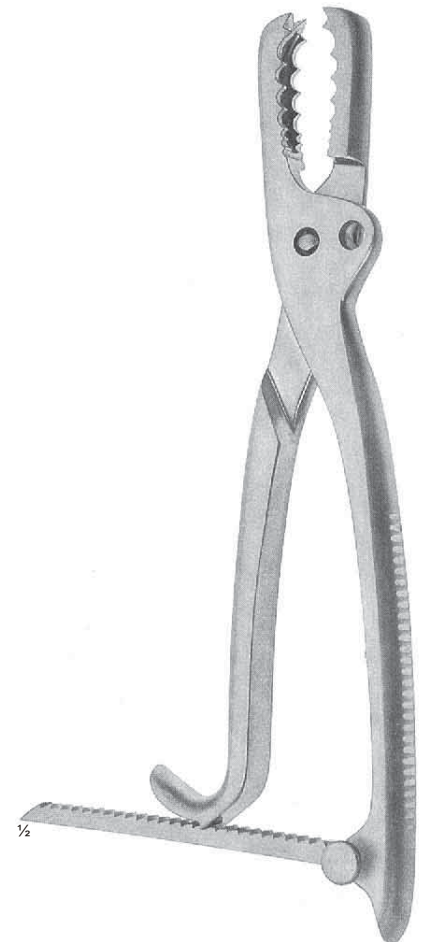

1/2

FARABEUF-LAMBOTTE
 33-707-26
 26 cm, 10 1/4"



Bone Holding Forceps
Knochenhalte­zangen
Pinzas para huesos
Daviers
Tenaglie per ossa



033

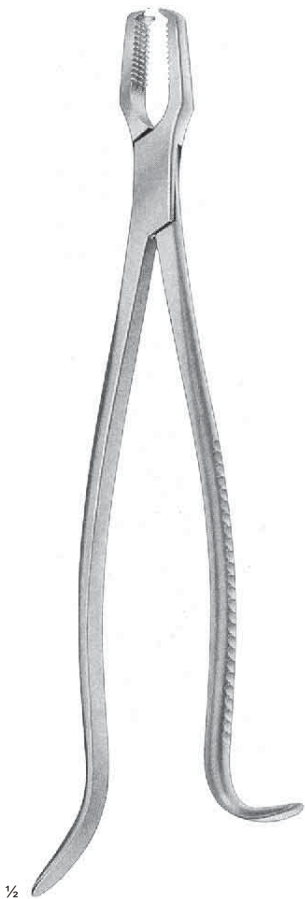
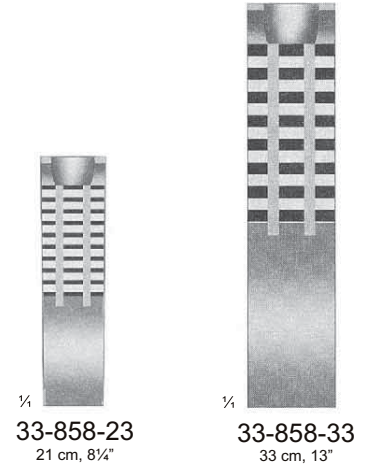
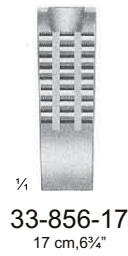
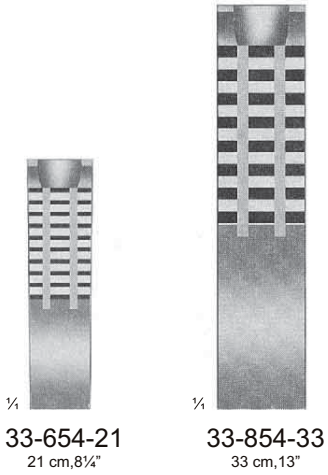

KERN-LANE
33-854-21
33-854-33



KERN-MINI
33-858-17



KERN
33-858-23
33-858-33



Bone Holding Forceps
 Knochenhaltezangen
 Pinzas para huesos
 Daviers
 Tenaglie per ossa



033



1/2

LAMBOTTE

- 33-866-22 22 cm, 8 3/4"
- 33-866-27 27 cm, 8 1/2"
- 33-866-30 30 cm, 12"



1/2

LAMBOTTE

- 33-868-22
- 33-868-33



10 mm

1/4

33-868-22
22 cm, 8 3/4"



13 mm

1/4

33-868-26
26 cm, 10 1/4"



16 mm

1/4

33-868-33
33 cm, 13"



14 mm

33-869-19
19 cm, 7 1/2"



16 mm

33-869-26
26 cm, 10 1/4"



1/2

LAMBOTTE

- 33-869-19
- 33-869-26



Bone Holding Forceps
 Knochenhalte­zangen
 Pinzas para hesos
 Daviers
 Tenaglie per ossa



033

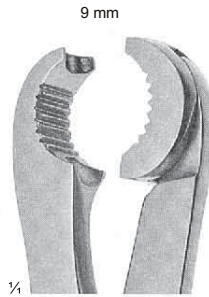

33-870-22
 22 cm, 8¾"

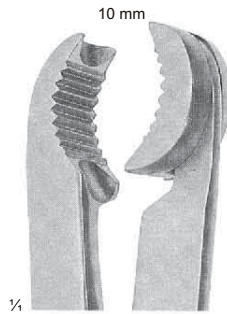

33-870-27
 27 cm, 10½"

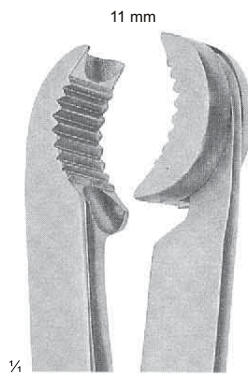

33-870-30
 30 cm, 12"



LAMBOTTE
 33-870-22
 33-870-30

Adjustable, 1 jaw swiveled
 Verstellbar, 1Maulteil beweglich
 Ajustavble, 1 mandibula movable
 à crémaillère, 1 more mobile
 Regolabili, 1 mandibola mobile

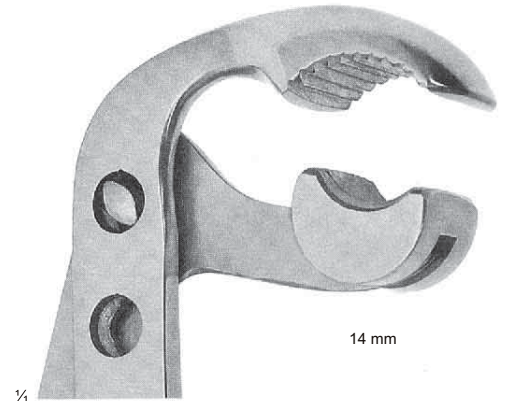

LAMBOTTE
 33-871-21
 21 cm, 8¼"

Adjustable, 1 jaw swiveled
 Verstellbar, 1Maulteil beweglich
 Ajustavble, 1 mandibula movable
 à crémaillère, 1 more mobile
 Regolabili, 1 mandibola mobile

Bone Holding Forceps

Knochenhalte­zangen
Pinzas para huesos
Daviers
Tenaglie per ossa

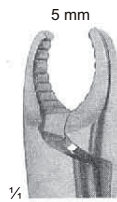

33-872-18
33-872-18
18 cm, 7"

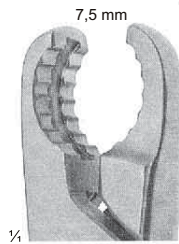

33-872-23
33-872-23
23 cm, 9"

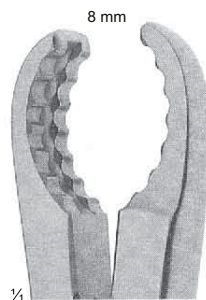

33-872-25
33-872-25
25 cm, 10"

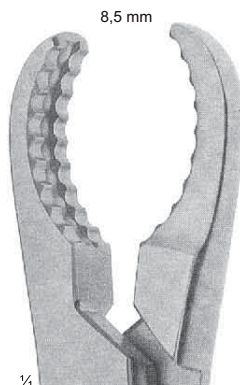

33-872-28
33-872-28
28 cm, 11"



ULRICH
33-872-18
33-872-28



ULRICH
33-873-28
33-873-28



Bone Holding Forceps
Knochenhalte­zangen
Pinzas para huesos
Daviers
Tenaglie per ossa



033



1/2

VERBRUGGE
33-875-17
33-875-27

With lip joint
Mit Lappenverschluss
Con cierre de labio
Avec fermeture à lambeaux
Con chiusura a tela



5 mm

1/4

33-875-17
17,5 cm, 6 3/4"



10.5 mm

1/4

33-875-26
26 cm, 10 1/2"



9,5 mm

1/4

33-875-25
25 cm, 10"



12 mm

1/4

33-875-27
27 cm, 11"



2,5 mm



¼

33-877-15
 15 cm, 6"

10 mm



¼

33-877-26
 26 cm, 10¼"

6,5 mm



¼

33-877-19
 19 cm, 7½"

11 mm



¼

33-877-28
 28 cm, 11"

9,5 mm

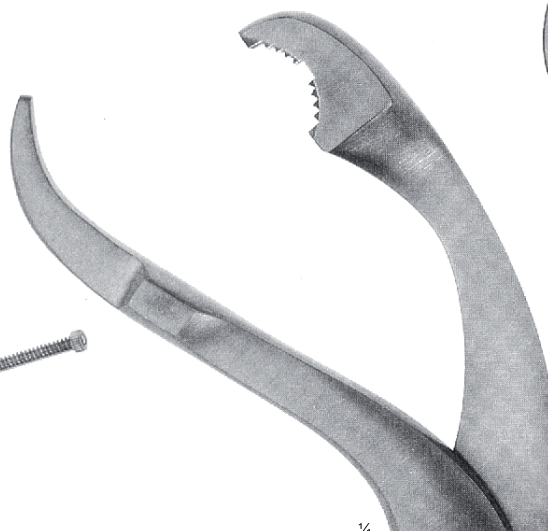

¼

33-877-24
 24 cm, 9½"



½

33-877-15
33-877-28

Self-centering forceps with thread fixation
 Selbstzentriert mit Gewindesperre
 Autocentrante con cremallera de tuerca
 Autostatique, à crémaillère
 Pinze autocentranti con blocco di filettatura

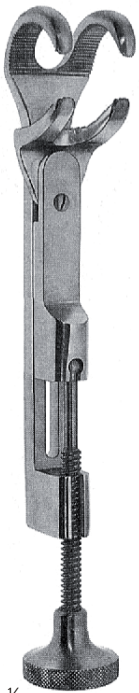

½

LOWMANN HOGLUND
 35-880-19
 19 cm, 7½"

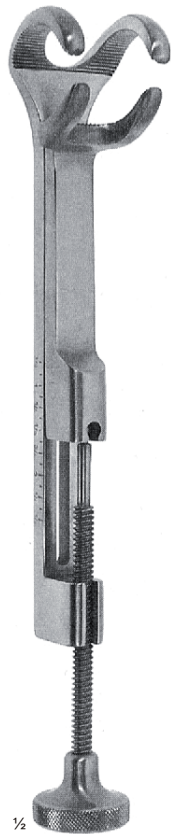

½

LOWMANN-LAMBERT
 35-890-18
 18 cm, 7"
 35-890-20
 20 cm, 8"
 35-890-22
 22 cm, 8¾"

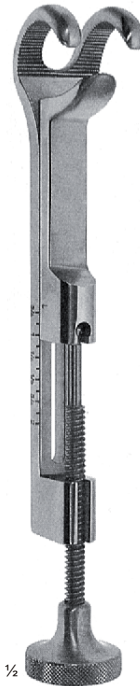

½

GERSTER LOWMANN
 35-891-18
 18 cm, 7"
 35-891-20
 20 cm, 8"
 35-891-22
 22 cm, 8¾"

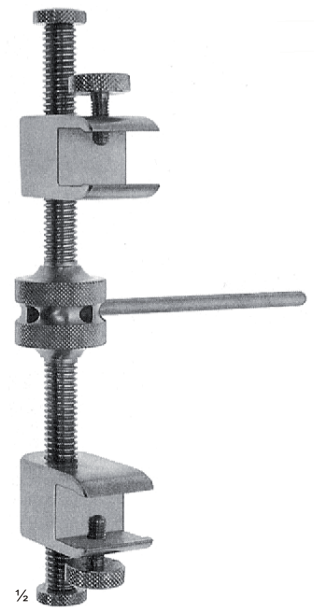

½

GERSTER
 35-892-00

Traction bar for bone clamps
 Distrationsklammer für Knochen-
 halteklammern
 Barra de tracción para pinzas
 porta-huesos
 Tracteur pour daviers
 Barra di trazione per tenaglie
 per ossa

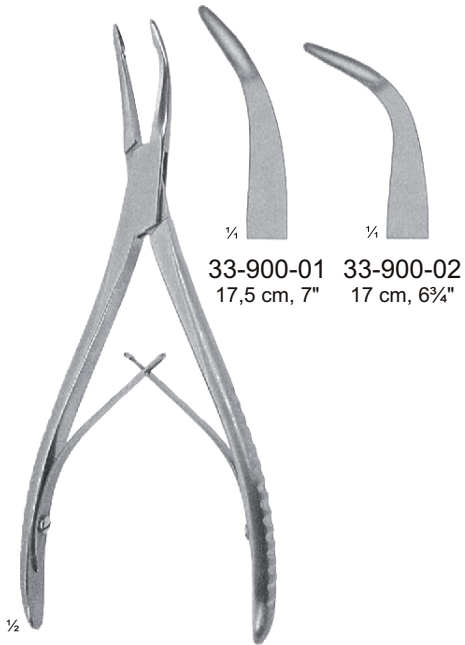

33-900-01 33-900-02
 17,5 cm, 7" 17 cm, 6¾"

STELLBRINK
 33-900-01
 33-900-02

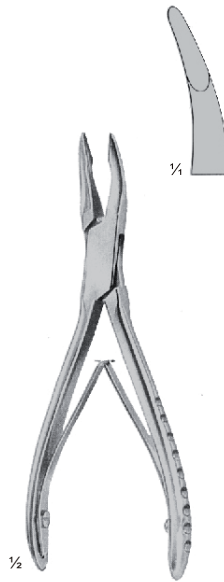

**MINI
 FRIEDMAN**
 33-901-12
 12 cm, 5"

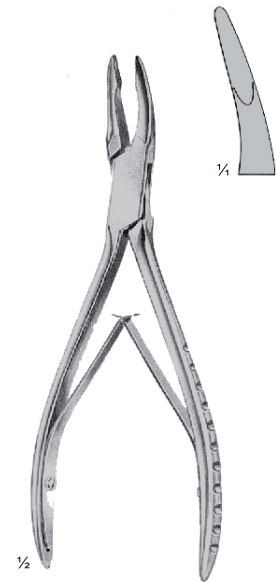

FRIEDMAN
 33-902-14
 14 cm, 5½"



**FRIEDMAN
 VICKERS**
 33-904-14
 14 cm, 5½"

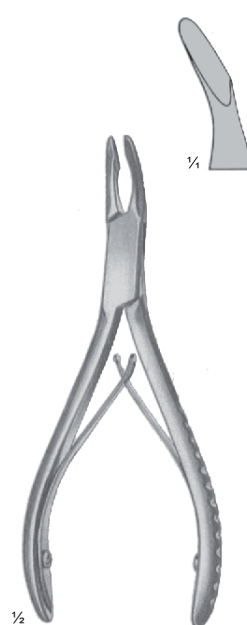

CLEVELAND
 33-906-14
 14 cm, 5½"

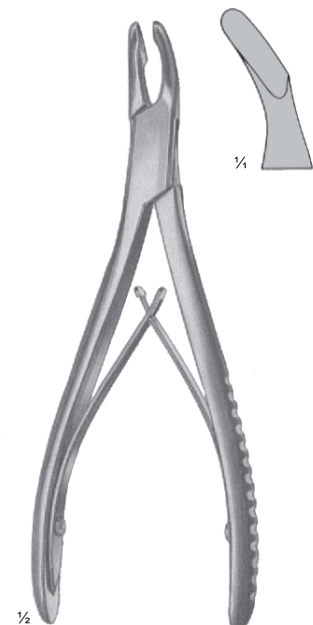

CLEVELAND
 33-908-17
 17 cm, 6¾"



Bone Rongeurs
 Hohmeißelzangen
 Pinzas-gubias
 Pincès-gouges
 Pinze per ossa



033

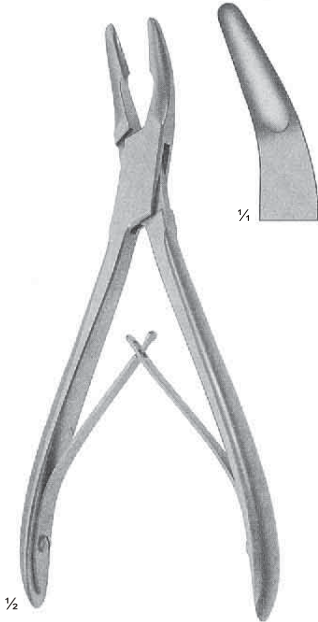

MEAD
 33-910-16
 16,5 cm, 6½"

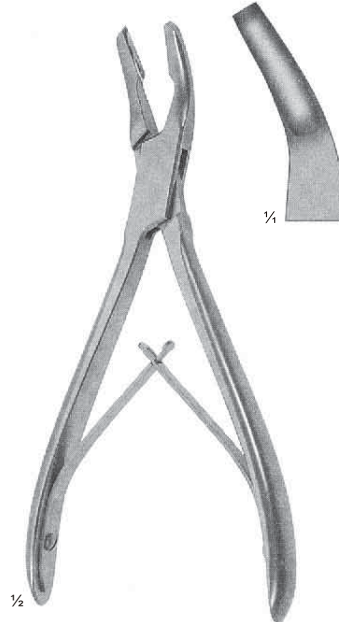

MEAD
 33-912-16
 16,5 cm, 6½"

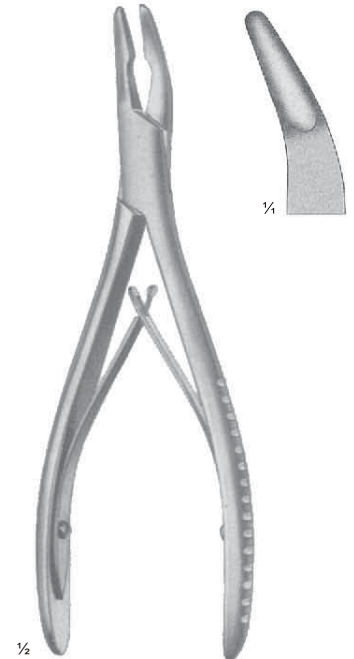

HARTMANN
 33-914-18
 18,5 cm, 7¼"



33-916-01 33-916-02
 18 cm, 7" 18 cm, 7"

JANSEN
 33-916-01
 33-916-02

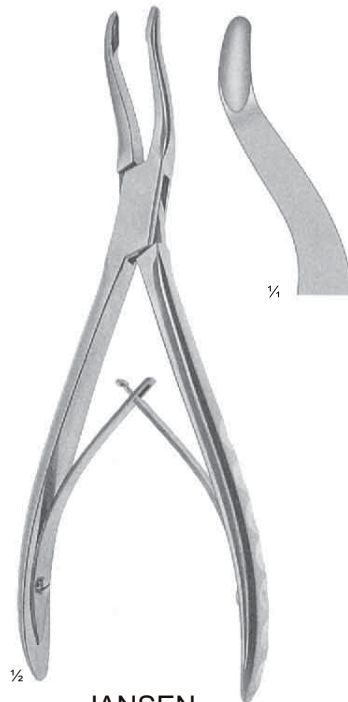

JANSEN
 33-917-19
 19 cm, 7½"



33-918-01 33-918-02
 16 cm, 6" 16 cm, 6"

LEMPERT
 33-918-01
 33-918-02

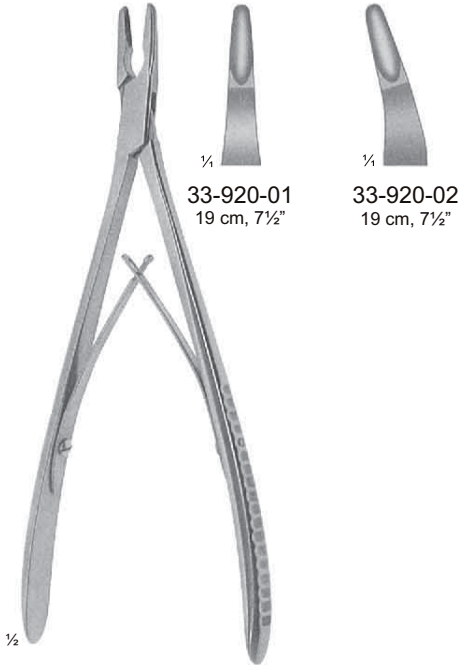

LEMPERT
33-920-01
33-920-02

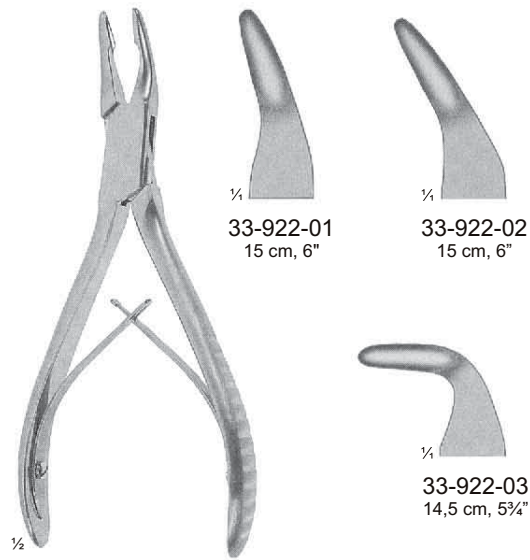

BLUMENTHAL
33-922-01
33-922-03

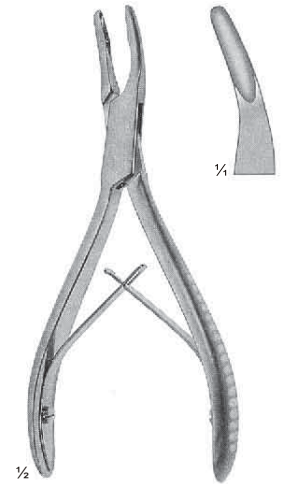

LUER FRIEDMAN
33-924-15
15 cm, 6"

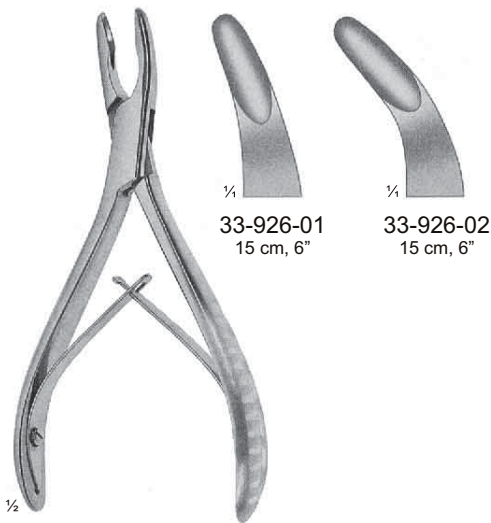

LUER
33-926-01
33-926-02
15 cm, 6"

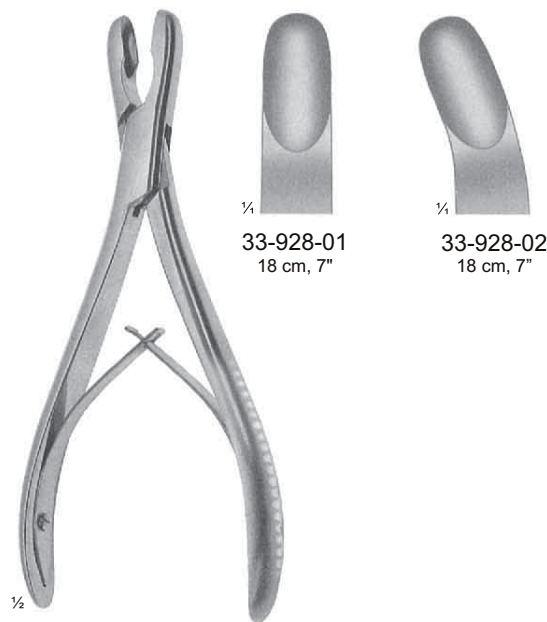

RUSKIN
33-928-01
33-928-02

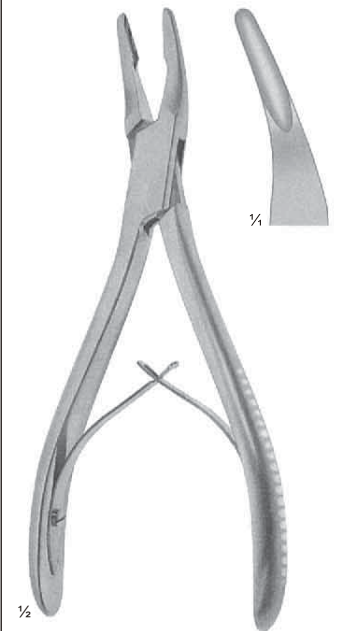

BEYER
33-930-18
18 cm, 7"



Bone Rongeurs
 Hohlmeißelzangen
 Pinzas-gubias
 Pincès-gouges
 Pinze per ossa



033

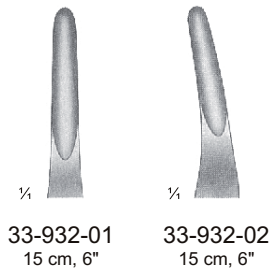
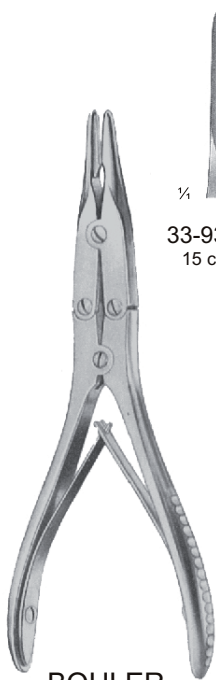

BOHLER
 33-932-01
 33-932-02

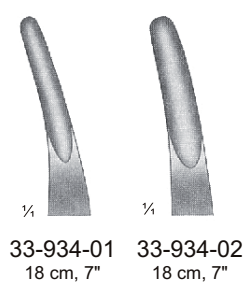

BEYER
 33-934-01
 33-934-02



ZAUFAL
 JANSEN
 33-936-18
 18 cm, 7"



MAYFIELD
 33-938-17
 17 cm, 6¾"

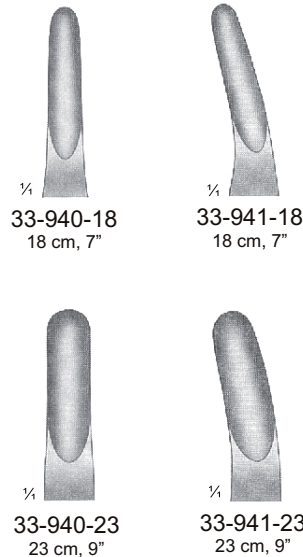

RUSKIN
 33-940-18
 33-941-23

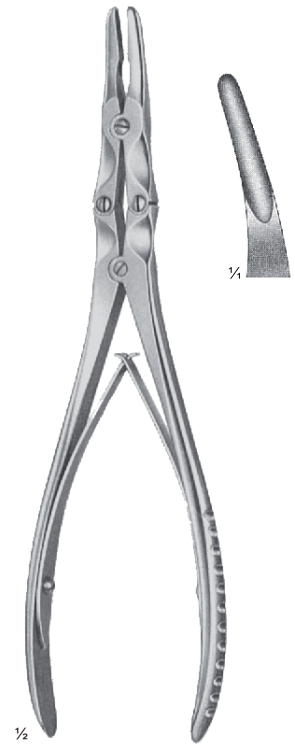

MARQUARDT
 33-942-20
 20 cm, 8"

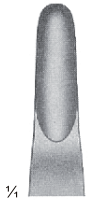

¼



¼

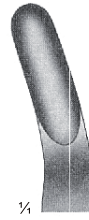

¼

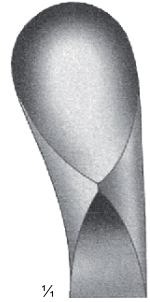

¼



½

STILLE
 33-943-23
 23 cm, 9"

Laterally curved
 Seitwärts gebogen
 Curvas lateral
 Courbure latérale
 Curva lateralmente



½

STILLE-RUSKIN
 33-944-23
 23 cm, 9"

Laterally curved
 Seitwärts gebogen
 Curvas lateral
 Courbure latérale
 Curva lateralmente

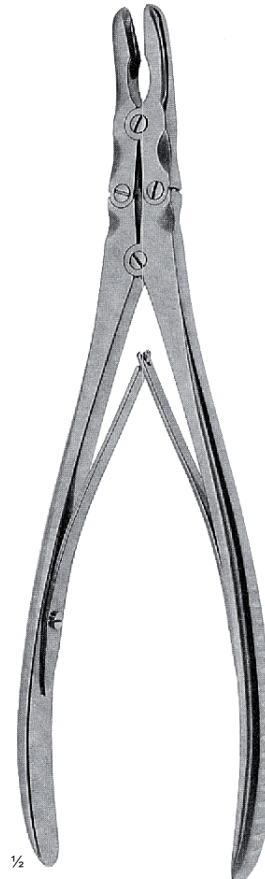

½

RUSKIN
 33-946-23
 23 cm, 9"



½

SEMB
 31-126-22
 22 cm, 9"



Bone Rongeurs
 Hohlmeißelzangen
 Pinzas-gubias
 Ponces-gouges
 Pinze per ossa



033

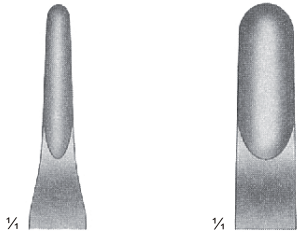

¼
 33-950-01
 24 cm, 9½"

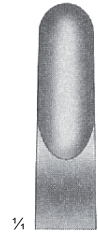

¼
 33-950-02
 24 cm, 9½"



¼
 33-951-01
 24 cm, 9½"



¼
 33-951-02
 24 cm, 9½"

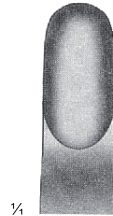

¼
 33-952-22
 22 cm, 8¾"

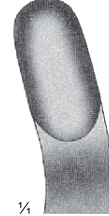

¼
 33-952-22
 22 cm, 8¾"



¼
 33-953-01
 23 cm, 9"
 2 mm



¼
 33-953-02
 23 cm, 9"
 3 mm



LEKSELL-STILLE
 33-950-01
 33-950-02

Laterally curved
 Seitwärts gebogen
 Curvas lateral
 Courbure latérale
 Curva lateralmente



FRYKHOLM
 33-951-01
 33-951-02

Laterally curved
 Seitwärts gebogen
 Curvas lateral
 Courbure latérale
 Curva lateralmente



LUER-STILLE
 33-952-22
 33-952-22

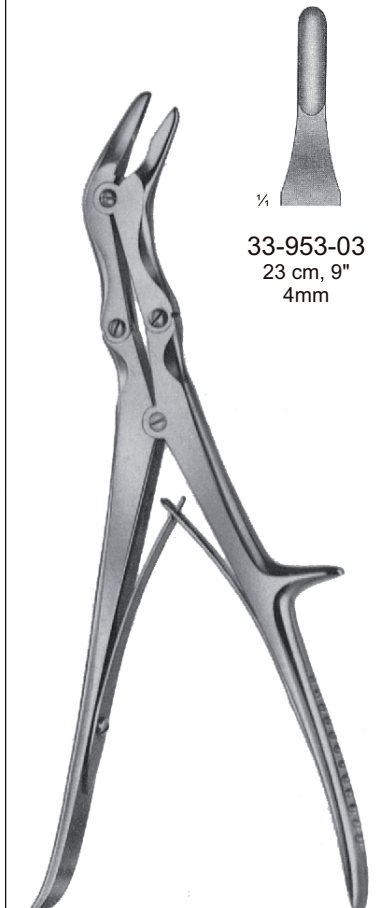

¼
 33-953-03
 23 cm, 9"
 4mm

ECHLIN
 33-953-01
 33-953-03



Bone Rongeurs
 Hohlmeißelzangen
 Pinzas-gubias
 Pincés-gouges
 Pinze per ossa



033

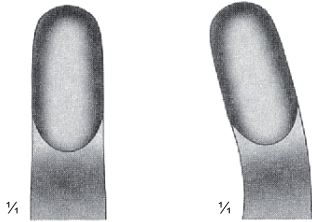

33-955-22
22 cm, 8¾"

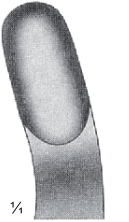

33-955-22
22 cm, 8¾"

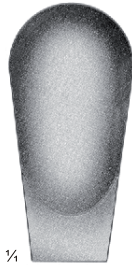

33-956-23
23 cm, 9"

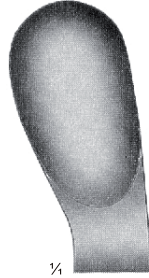

33-957-23
23 cm, 9"

33-956-27
27 cm, 10½"

33-957-27
27 cm, 10½"



33-958-01
30 cm, 12"

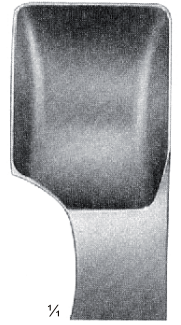

33-958-02
30 cm, 12"



LUER-STILLE
33-954-22
33-955-22



LUER-STILLE
33-956-23
33-957-27



SAUERBRUCH
33-958-01
33-958-02



Bone Cutting Forceps
 Knochensplitterzangen
 Pinzas cortantes para huesos
 Pincas coupantes
 Cesoie per ossa



033



MARKWALDER
 31-126-20
 20 cm, 8"

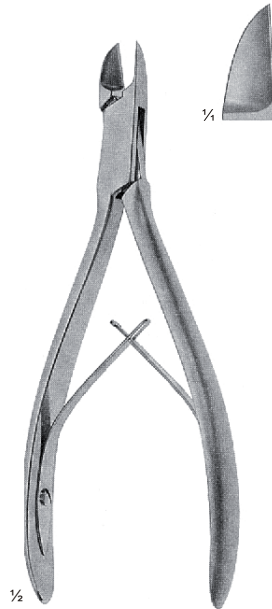

LITTAUER-LISTON
 33-962-15
 15,5 cm, 6"

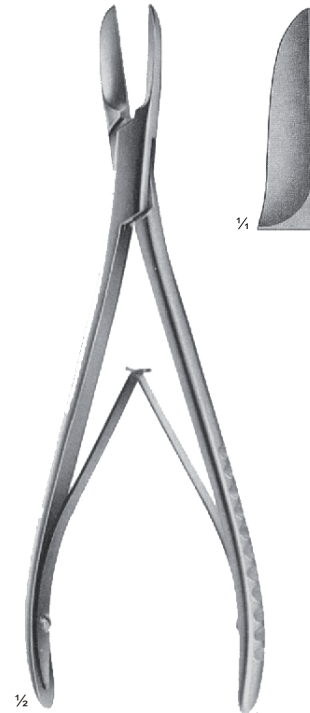

COTTLE
 33-964-19
 19 cm, 7½"



LISTON
 33-966-14
 33-966-22



33-966-14
 14 cm, 5½"



33-966-17
 17 cm, 6¾"



33-966-19
 19 cm, 7½"



33-966-22
 22 cm, 8¾"



LISTON
 33-967-14
 33-967-22



33-967-14
 14 cm, 5½"



33-967-17
 17 cm, 6¾"

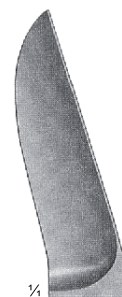

33-967-19
 19 cm, 7½"



33-967-22
 22 cm, 8¾"



33-968-01
15 cm, 6"

33-968-02
17 cm, 6¾"

CLEVELAND
33-968-01
33-968-02



33-970-01
15 cm, 5¾"

33-970-02
15 cm, 5¾"

BOHLER
33-970-01
33-970-02

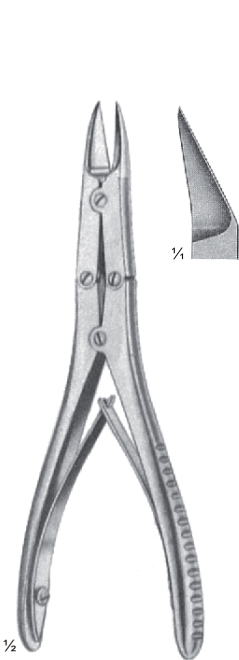

McINDOE
33-971-15
15 cm, 5¾"

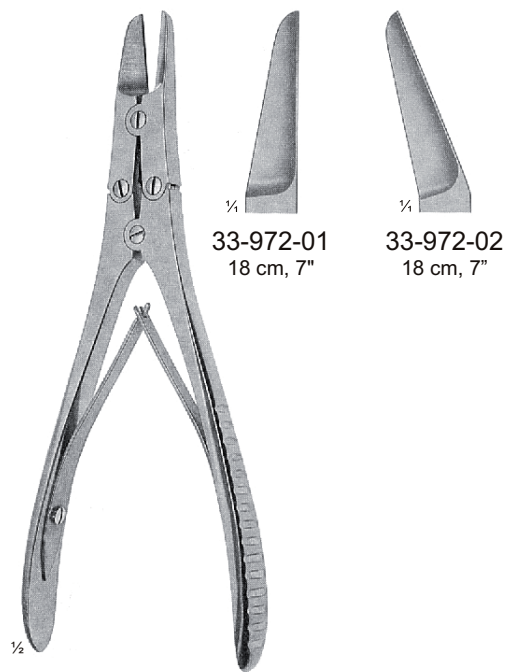

33-972-01
18 cm, 7"

33-972-02
18 cm, 7"

RUSKIN
33-972-01
33-972-02



33-973-01
18,5 cm, 7¼"

33-973-02
18,5 cm, 7¼"

RUSKIN-LISTON
33-973-01
33-973-02



Bone Cutting Forceps
Knochensplitterzangen
Pinzas cortantes para huesos
Pincès coupantes
Cesoie per ossa



033

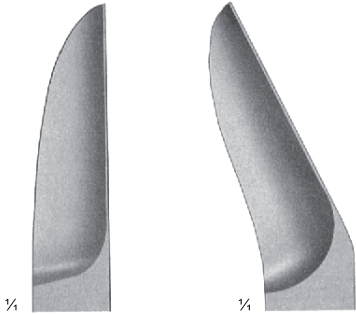

33-975-01
24 cm, 9½"

33-975-02
24 cm, 9½"



¼

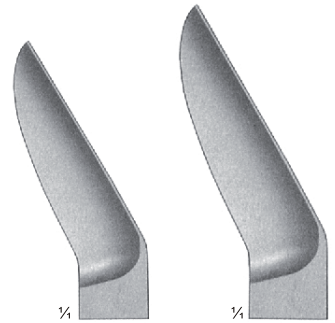

31-132-27
23 cm, 9¼"

31-133-27
27 cm, 10¾"



½

LISTON
33-975-01
33-975-02



½

STILLE-LISTON
31-130-27
27 cm, 10½"



½

STILLE-LISTON
31-132-27
31-133-27

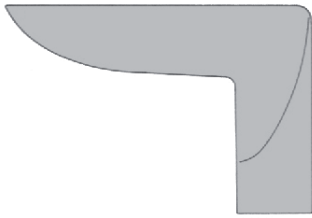

½

LISTON-STILLE
 33-978-27
 27 cm, 10½"

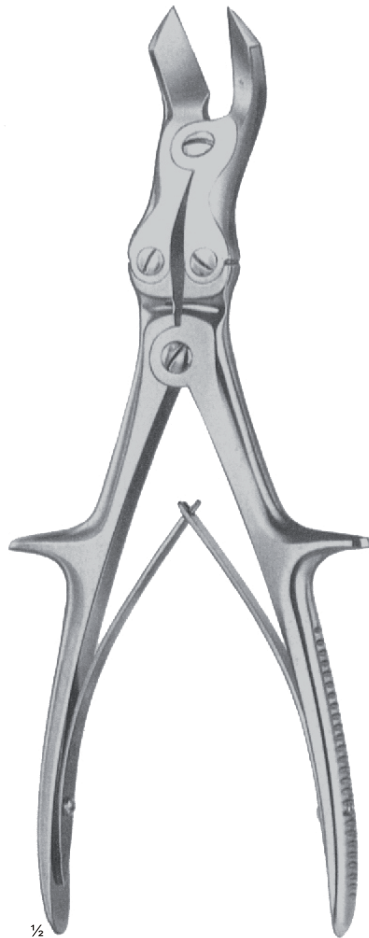
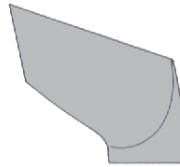

½

LISTON-KEY-HORSLEY
 31-133-27
 27 cm, 10½"

Bone Cutting forceps, S - shaped, for posterior rib stumps

Knochensplitterzange, doppel gebogen, für hintere rippenstümpfe

Pinza cortante para huesos, double curvada, para los muñones de las costillas posteriores

Pincès coupantes à os, double courbure pour extrémité des côtes postérieures

Cesoia per ossa, ad „s" per estremità delle costole posteriori

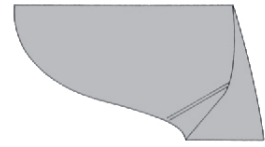

½

SEMB
 31-137-24
 24 cm, 9½"

Bone cutting forceps, curved sideways, for anterior rib stumps

Knochensplitterzange, seitwärts gebogen, für vordere Rippenstümpfe

Pinza cortante para huesos, curvada lateral, para los muñones de las costillas anteriores

Pincès coupantes à os, courbure latérale pour extrémité des côtes antérieures per le estremità delle costole anteriori



Finger Ring Saws
 Fingerringsägen
 Sierras para abrir anillos
 Scies pour bagues
 Seghe per anelli

Finger Nail Instruments
 Fingernagel-Instrumente
 Instrumentos para uñas
 Instruments à ongles
 Strumenti per unghie



033



33-990-01

33-990-16
16 cm, 6 1/4"

Finger ring saw
Fingerringaäge
Sierra para abrir anillos
Scie pour bagues
Segha per anelli



33-991-01

33-991-16
16,5 cm, 6 1/2"

Finger ring saw
Fingerringaäge
Sierra para abrir anillos
Scie pour bagues
Segha per anelli



33-992-13
13 cm, 5"

Nail splitting forceps
Nagelspaltzange
Pinza corta-uñas
Pinca à ongles
Pinza per unghie

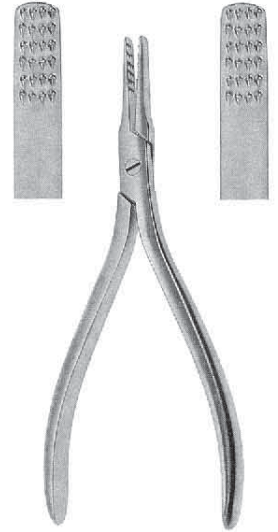

33-994-13
13,5 cm, 5 1/4"

Nail extracting forceps
Nagelausreißzange
Pinza arranca-uñas
Pince pour extraction des ongles
Pinza per estrazione delle unghie



33-996-01
Ø 1,2 mm



33-996-02
Ø 1,6 mm



33-996-03
Ø 2,0 mm



33-996-01
33-996-03

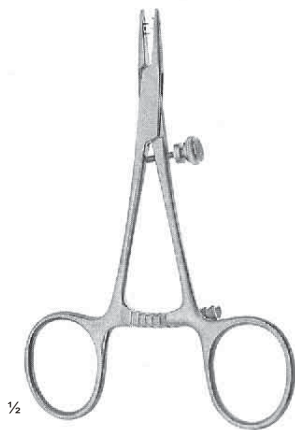

33-997-13
13 cm, 5"

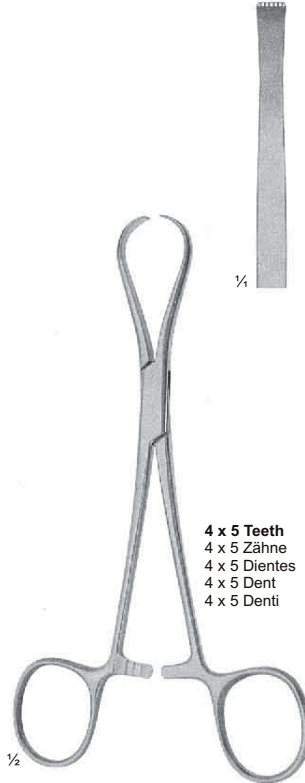

JACKSON
33-998-15
15,5 cm, 6"

4 x 5 Teeth
4 x 5 Zähne
4 x 5 Dientes
4 x 5 Dent
4 x 5 Denti

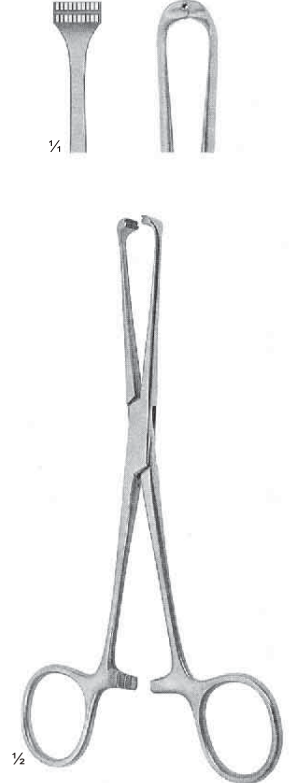

STEINMANN
33-999-16
16 cm, 6 1/2"

035



Bone Surgery
Knochenchirurgie
Cirurgía ósea
Chirurgie osseuse
Chirurgia ossea



Wire Holding Forceps

Drahtfaßzangen
Pinzas para extraer alambres
Pincas tire-broches
Pinze porta cavo



ROCKGRIP

035

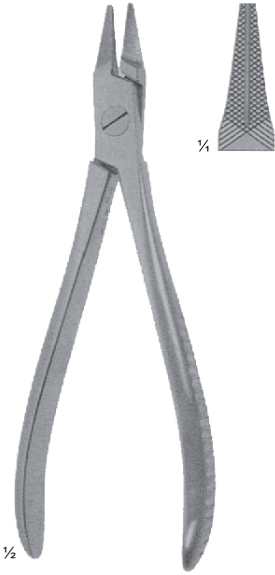

35-670-16 59-150-16
16 cm, 6¼"



35-672-01 59-150-01
35-672-02 59-150-02
17 cm, 6¾"

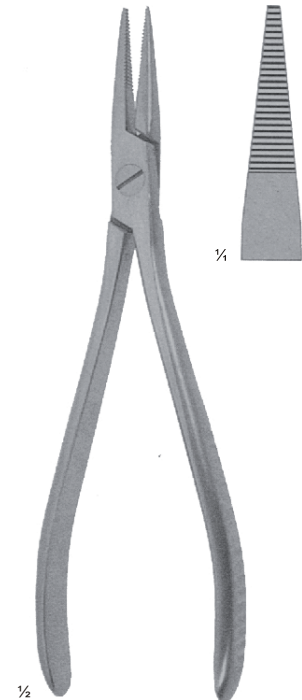

35-674-19
19 cm, 7½"

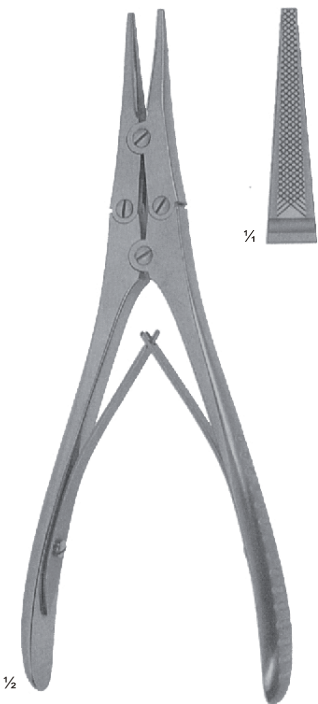

35-676-18
18 cm, 7"

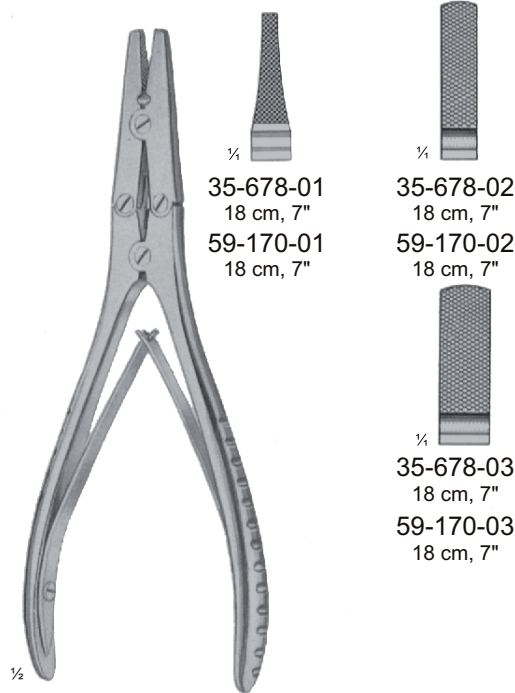

35-678-01 59-170-01
35-678-02 59-170-02
35-678-03 59-170-03
18 cm, 7"

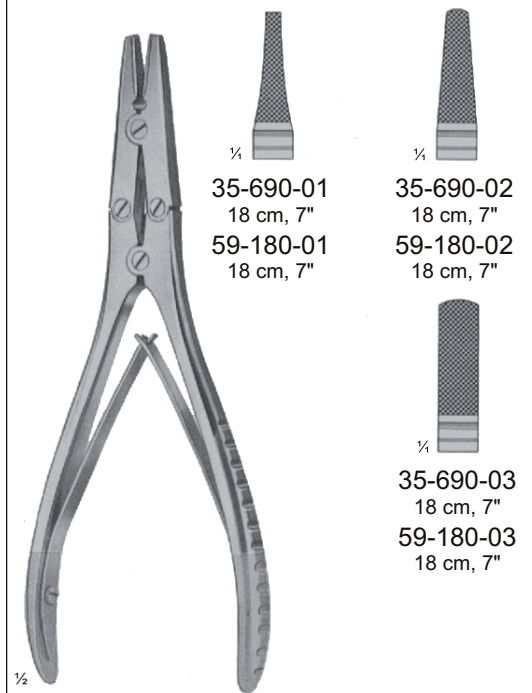

35-690-01 59-180-01
35-690-02 59-180-02
35-690-03 59-180-03
18 cm, 7"

Wire Twisting Forceps with tungsten carbide inserts

Drahtspannzangen mit Hartmetalleinlagen
 Pinzas cierra-hilos con bocas de carburo tungsteno
 Pincers serre-fils avec mors en tungstène
 Pinze gira cavo con morsi in carburo di tungsteno

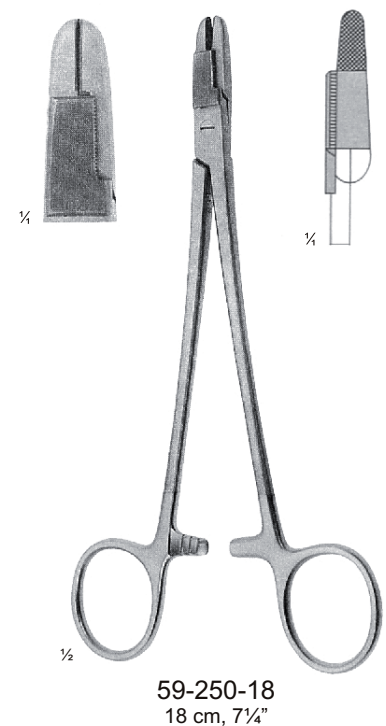
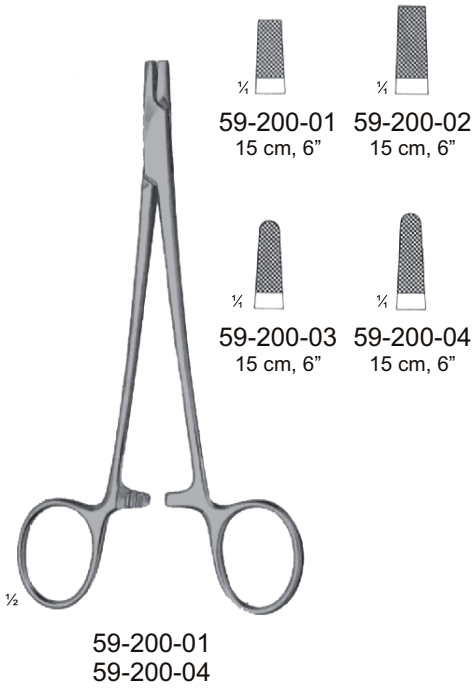

Wire Twisting Forceps with tungsten carbide inserts

Drahtspannzangen mit Hartmetalleinlagen
 Pinzas cierra-hilos con bocas de carburo tungsteno
 Pincers serre-fils avec mors en tungstène
 Pinze gira cavo con morsi in carburo di tungsteno



35-700-17
17 cm, 6½"



35-702-18
18 cm, 7"



35-710-16
16 cm, 6¼"



35-712-15
15 cm, 6"

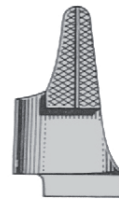

35-716-14
14,5 cm, 5¾"

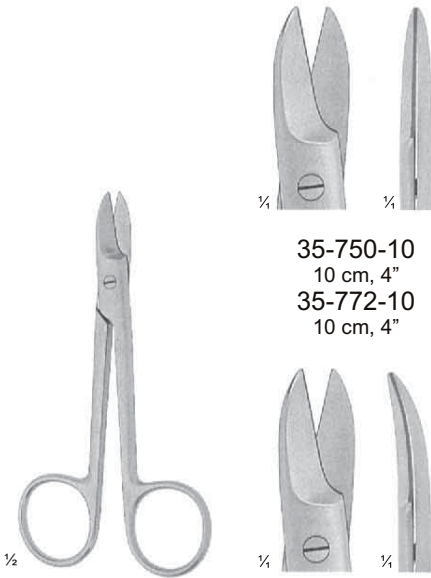

35-750-10
10 cm, 4"
35-772-10
10 cm, 4"

35-751-12
12 cm, 4¾"
35-753-12
12 cm, 4¾"

BEEBEE
35-750-10
35-753-10

For soft wire up to diam.
für weichen Draht bis ø
para blandos hasta un diam. de
pour couper les fils moux jusqu'à ø
per cavi leggeri con ø superiore a

0,4 mm

For hard wire up to diam.
für harten Draht bis ø
para duros hasta un diam. de
pour couper les fils durs jusqu'à ø
per cavi duri con ø superiore a

0,3 mm

35-752-10
35-753-12

1 blade serrated
1 blatt gezahnt
1 hoja dentada
1 lame dentelée
1 lama dentata

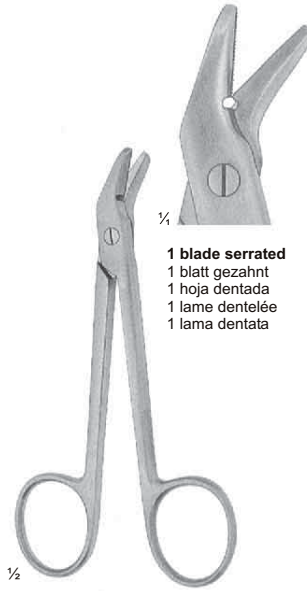

1 blade serrated
1 blatt gezahnt
1 hoja dentada
1 lame dentelée
1 lama dentata

UNIVERSAL
35-760-12
12 cm, 4¾"

for soft wire up to diam.
für weichen Draht bis ø
para blandos hasta un diam. de
pour couper les fils moux jusqu'à ø
per cavi leggeri con ø superiore a

1,2 mm

for hard wire up to diam.
für harten Draht bis ø
para duros hasta un diam. de
pour couper les fils durs jusqu'à ø
per cavi duri con ø superiore a

0,8 mm



with tungsten carbide edges
mit hartmetallschneiden
con filos de carburo tungsteno
avec mors tungstène
con inserti in carburo di tungsteno

1 blade serrated
1 blatt gezahnt
1 hoja dentada
1 lame dentelée
1 lama dentata

UNIVERSAL
51-296-12
12 cm, 5"

for soft wire up to diam.
für weichen Draht bis ø
para blandos hasta un diam. de
pour couper les fils moux jusqu'à ø
per cavi leggeri con ø superiore a

1,2 mm

for hard wire up to diam.
für harten Draht bis ø
para duros hasta un diam. de
pour couper les fils durs jusqu'à ø
per cavi duri con ø superiore a

0,8 mm



LISTER
37-114-15
37-114-18



37-114-15
15 cm, 6"



37-114-18
18 cm, 7"

Universal bandage and cloth scissors, made of acid-proof stainless steel, with 1 serrated blade and plastic handles, autoclavable up to 134°C.

Universal Verband- und Klederstoffschere aus rostfreiem, säurebeständigem Stahl, mit 1 gezahnten Blatt und Kunststoffgriffen, bis 134°C im Autoklaven sterilisierbar.

Tijera univesal para vendajes y tela, acero inoxidable y real-stente a los ácidos, con 1 hoja dentada y mangos de plástico, esterilizable en autoclave hasta 134°C.

Ciseaux universels pour étoffes en acier inox, avec 1 lame crantée et anneaux en plastique, autoclavables à 134°C.

Cesoio per bendaggi e vestiti, in acciaio inox resistente agli acidi con 1 lama dentata, manico in plastica, sterilizzabile in autoclave fino 134°C.



Wire Cutters
Drahtkneifzangen
Alicates corta-alambres
Pincas à couper le fil
Tenaglie tagliafili



ROCK CUT 035

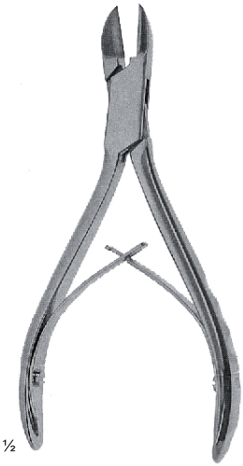

35-780-11
11 cm, 4½"
35-780-13
13 cm, 5"
35-780-15
15 cm, 6"



35-790-18
18,5 cm, 7¼"



ø1,5 mm

ø1,5 mm

59-526-18
18 cm, 7"



59-530-16
16 cm, 5½"



59-532-22
22 cm, 8¾"

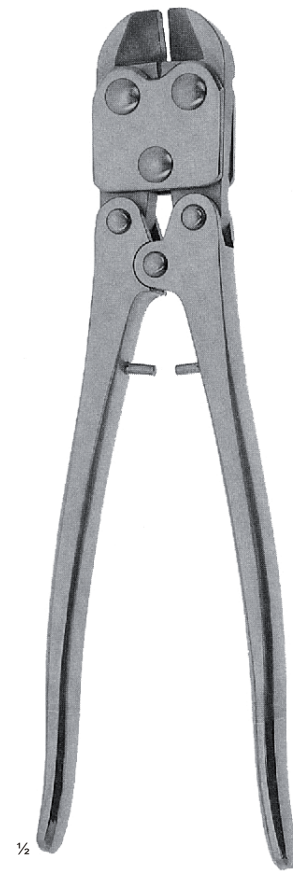

35-800-23
23,5 cm, 9¼"



Wire Cutters

Drahtkneifzangen
Alicates corta-alambres
Pinces à couper le fil
Tenaglie tagliafili



ROCK CUT

035



35-810-16
16 cm, 6¼"



35-812-16
16 cm, 6¼"

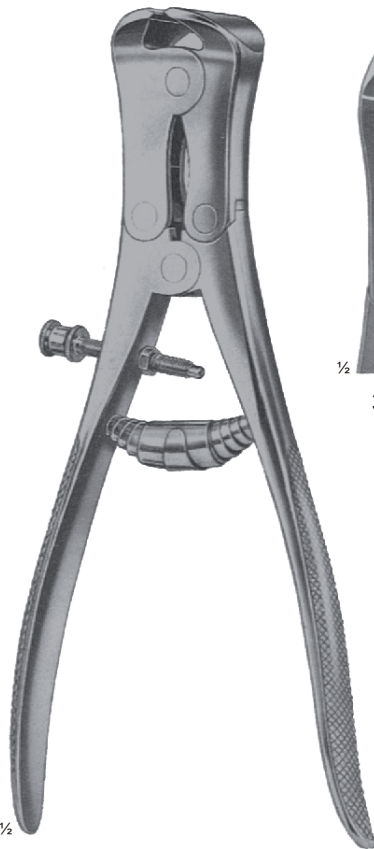

35-814-23
23 cm, 9"



35-816-25
25 cm, 9¾"



35-818-48 48 cm, 18¾"
35-818-54 54 cm, 21¼"

59-550-48 48 cm, 18¾"
59-550-54 54 cm, 21¼"

Wire Guides

Drahtumführungsadeln
 Agujas pasa-hilos
 Aiguilles passe-fils
 Aghi passafili

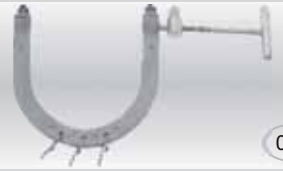

DEMEL
 35-820-27
 35-820-30

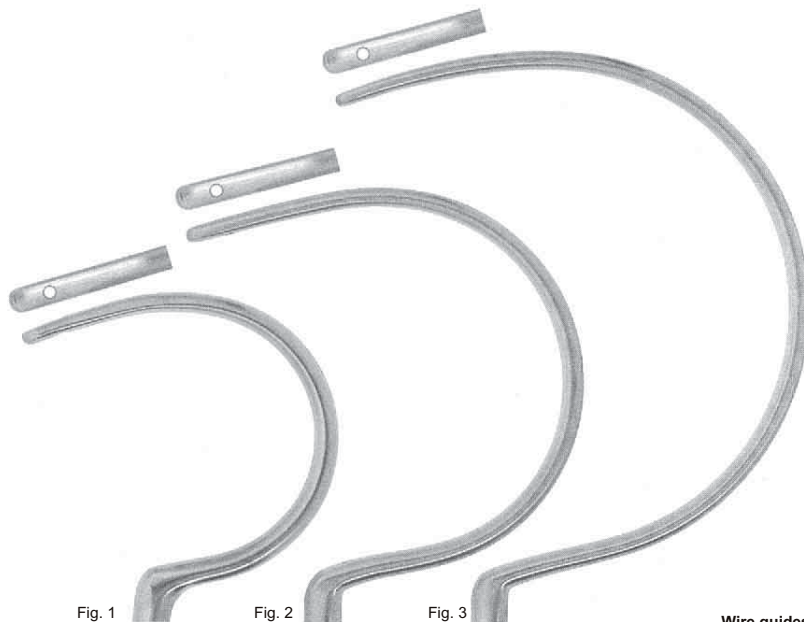

Fig. 1

Fig. 2

Fig. 3

35-820-27
 27,5 cm, 10¾"

35-820-28
 28,5 cm, 11¼"

35-820-30
 30,5 cm, 12"

Wire guides
 Drahtumführungsadeln
 Agujas pasa hilos
 Aiguilles passe-fils
 Guida cavo



½

35-822-24
 35-822-27



Fig. 1

Fig. 2

35-822-24
 24 cm, 9½"

35-822-27
 27 cm, 10¾"

Hollow,sharp
 Hohl,spitz
 Hueco,agudo
 Creux,pointu
 Cavo,acuto

Hollow,sharp
 Hohl,spitz
 Hueco,agudo
 Creux,pointu
 Cavo,acuto



½

35-823-22
 22,5 cm, 9"

Hollow,sharp
 Hohl,spitz
 Hueco,agudo
 Creux,pointu
 Cavo,acuto

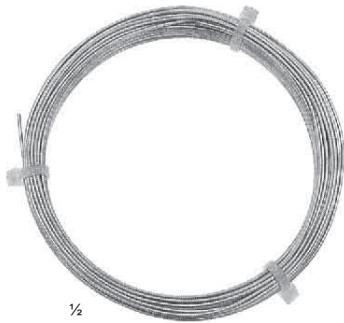

½

mm ø	malleabile
0,2	35-825-01
0,3	35-825-02
0,4	35-825-03
0,5	35-825-04
0,6	35-825-05
0,7	35-825-06
0,8	35-825-07
0,9	35-825-08
1,0	35-825-09
1,2	35-825-10
1,5	35-825-11



½

LOUTE
35-830-21
 21 cm, 8¼"

Wire tightener, with movable tip, for wires up to 1.0 mm diam,

Drahtspanner mit an der Spitze eingebauter beweglicher Drahtspannbüchse für Cerclage-drähte bis ø 1 mm

Tensor cierra-hilo con manguito móvil en la punta, para hilos de cerclaje hasta ø 1 mm

Serre-fil avec manche mobile intégré à la pointe pour fil de cerclage jusqu'à ø 1 mm

Trenditore serra filo con manico mobile sulla punta, per filli di cerchiaggio da 1 mm. di ø

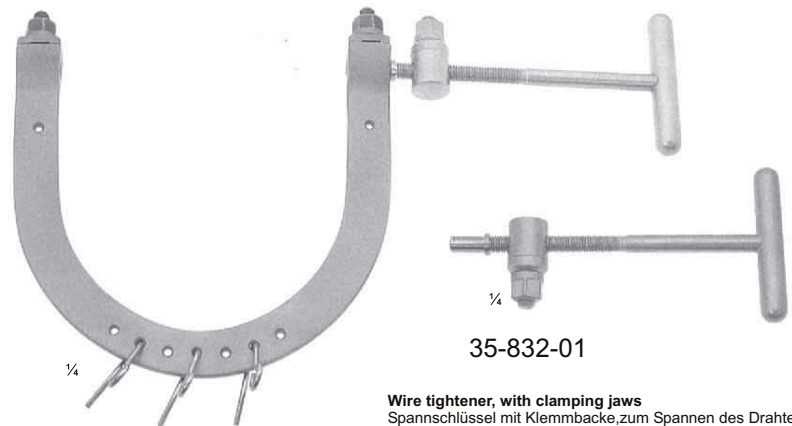

¼

35-832-01

Wire tightener, with clamping jaws
 Spanschlüssel mit Klemmbacke, zum Spannen des Drahtes
 Tensor de alambres
 Tendeur de broches avec mors clampants
 Strumento tenditore con morso a presa

Depth Tiefe Profundidad Profondité Profondità	Width Weite Anchura interior Largeur ouverte Larghezza interna		Application Anwendung Aplicación Application Applicazione				
35-830-01	95 mm, 3¾"	70 mm, 2¾"	Arm and elbow	Arm und Ellenbogen	Brazy y code	Bras et poignet	Braccio e gomito
35-830-02	95 mm, 3¾"	110 mm, 4¾"	calcaneus	Fersenbein	clacáneo	calcaneum	calcagno
35-830-03	105 mm, 4¾"	100 mm, 4"	knee	Knie	rodilla	genou	ginocchio
35-830-04	120 mm, 4¾"	120 mm, 4¾"	knee	Knie	rodilla	genou	ginocchio
35-830-05	135 mm, 5¼"	130 mm, 5¼"	knee	Knie	rodilla	genou	ginocchio
35-830-06	155 mm, 6"	155 mm, 6"	femur	Oberschenkel	fémur	fémur	femore
35-830-07	200 mm, 8"	155 mm, 6"	hip	Hüfte	coxa	hanche	anca

Wire traction bow with 3 traction hooks, to be used with KIRSCHNER wires up to 2,5 mm diam.
 Extensionsbügel mit 3 Zughaken, zur Verwendung mit KIRSCHNER Drähten bis ø 2,5 mm diam.
 Estribos para extensión con 3 ganchos de tracción, para agujas de KIRSCHNER hasta ø 2,5 mm
 Etriers à extension avec 3 crochets de traction, pour broches KIRSCHNER ø 2,5 mm
 Archi per trazione con 3 ganci di trazione, da impiegarsi con fill KIRSCHNER superiori a 2,5 mm di ø



KIRSCHNER

	cm	in
35-836-01	20	8
35-836-02	27	10½
35-836-03	33	13
35-836-04	38	15

Wire traction bow with 3 traction hooks, to be used with KIRSCHNER wires up to \varnothing 1,6 mm \varnothing 2,0 mm \varnothing 2,5 mm adjustable, hold wire securely

Extensionsbügel mit 3 Zughaken, zur Verwendung mit KIRSCHNER drähten bis \varnothing 1,6 mm \varnothing 2,0 mm, \varnothing 2,5 mm verstellbar, selbsthemmend

Estribo para extensión con 3 ganchos de tracción, para agujas de KIRSCHNER hasta \varnothing 1,6 mm \varnothing 2 mm, \varnothing 2,5 mm, ajustable, sujeto seguro de la aguja

Etrier à extension avec 3 crochets de traction, pour broches KIRSCHNER \varnothing 1,6 mm \varnothing 2 mm, \varnothing 2,5 mm, réglable, avec blocage des broches

Archi per trazione con 3 ganci di trazione, da impiegarsi con fili KIRSCHNER superiori a \varnothing 1,6 mm \varnothing 2 mm, \varnothing 2,5 mm, regolabile, filli in sicurezza

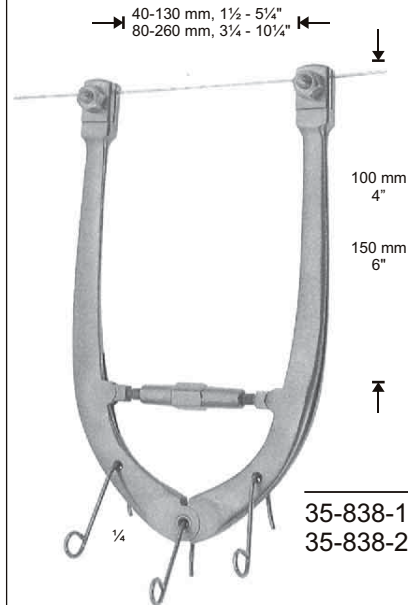

	cm	in
35-838-18	18x10	7x4
35-838-27	27x16	10½x6¼

Wire traction bow with 3 traction hooks, to be used with KIRSCHNER wires \varnothing up to \varnothing 2 mm diam, \varnothing 2,5 mm diam, adjustable

Extensionsbügel mit 3 Zughaken, zur Verwendung mit KIRSCHNER Drähten bis \varnothing 2 mm, \varnothing 2,5 mm verstellbar

Estribo para extensión con 3 ganchos de tracción, para agujas de KIRSCHNER hasta \varnothing 2 mm, 2,5 mm ajustable

Etrier à extension avec 1 crochet de traction, pour broches KIRSCHNER \varnothing 2 mm, 2,5 mm, réglable

Archi per trazione con 1 ganci di trazione, da impiegarsi con fili KIRSCHNER superiori a 2 mm di \varnothing 2 mm di \varnothing regolabile

Fixation discs
 Begrenzungsplatten
 Discos de fijación
 Disques de fixation
 Dischi di fissaggio



35-842-01

Pair, Paar, Par, Paire, Paio

Fixation discs for drill wires
 Fixierscheiben für Bohrdrähte
 Discos fijadores para taladros filiformes
 Disques de fixation pour broches
 Dischi fissatori per I perforatori filiformi



35-842-02

Pair, Paar, Par, Paire, Paio



35-842-03



35-842-04

Screw nut wrench
 Mutternschlüssel
 Llave de tuercas
 Clé de serrage
 Chiave per madreviti



35-842-05

19 cm, 7½"

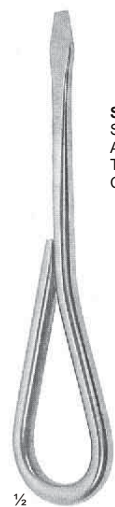

35-842-06

Screw driver
 Schraubendreher
 Atornillador
 Tourne-vis
 Cacciavite



KIRSCHNER

	cm	in
35-840-01	20	8
35-840-02	27	10½
35-840-03	33	13
35-840-04	38	15

Wire traction bow with 3 traction hooks, to be used with KIRSCHNER wires up to ø 1,6 mm ø 2,0 mm ø 2,5 mm adjustable, hold wire securely

Extensionsbügel mit 3 Zughaken, zur Verwendung mit KIRSCHNER drähten bis ø 1,6 mm ø 2,0 mm, ø 2,5 mm verstellbar, selbsthemmend

Estribo para extensión con 3 ganchos de tracción, para agujas de KIRSCHNER hasta ø 1,6 mm ø 2 mm, ø 2,5 mm, ajustable, sujeto seguro de la aguja

Etrier à extension avec 3 crochets de traction, pour broches KIRSCHNER ø 1,6 mm ø 2 mm, ø 2,5 mm, réglable, avec blocage des broches

Archi per trazione con 3 gancci di trazione, da impiegarsi con fili KIRSCHNER superiori a ø 1,6 mm ø 2 mm, ø 2,5 mm, regolabile, filli in sicurezza

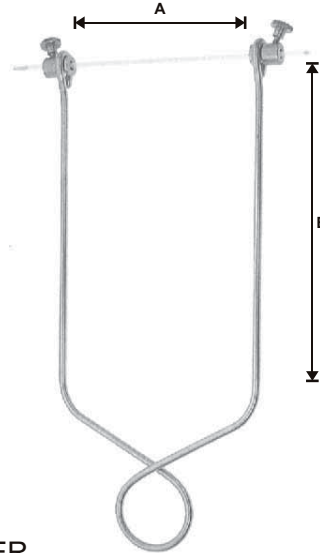

BOHLER

35-842-01
 160 x 190 mm
 6¼" x 7½"

Wire tractoin bow for arm, to be used with STEINMANN pins, ø 4 mm diam.

Extensionsbügel für Arm, zur Verwendung von STEINMANN Nägel ø 4 mm

Estribo para extensión de brazo, para clavos de STEINMANN ø mm diam.

Etrier de traction pour bras, utilisé ø 4 mm

Etrier de traction pour bras, utilisé avec clou de STEINMANN ø 4 mm

Cavo per arco di trazione per braccio, da impiegarsi con chiodi STEINMANN, ø 4 mm

35-842-02
 210 x 110 mm
 8¼" x 4¾"

Wire tractoin bow for thigh and knee, to be used with STEINMANN pins, 4 mm diam.

Extensionsbügel für Oberschenkel und knie, zur Verwendung von STEINMANN Nägel ø 4 mm

Estribo para extensión del muslo y de la rodilla, para clavos de STEINMANN ø mm diam.

Etrier de traction pour bras, utilisé ø 4 mm

Etrier de action pour femur et genou, utilisé avec clou de STEINMANN ø 4 mm

Cavo per arco di trazione per coscia e ginocchio, da impiegarsi con chiodi STEINMANN, ø 4 mm

35-842-03
 210 x 150 mm
 8¼" x 6"

Wire tractoin bow for thigh and knee, to be used with STEINMANN pins, 4 mm diam.

Extensionsbügel für Oberschenkel und knie, zur Verwendung von STEINMANN Nägel ø 4 mm

Estribo para extensión del muslo y de la rodilla, para clavos de STEINMANN ø mm diam.

Etrier de traction pour bras, utilisé ø 4 mm

Etrier de action pour femur et genou, utilisé avec clou de STEINMANN ø 4 mm

Cavo per arco di trazione per coscia e ginocchio, da impiegarsi con chiodi STEINMANN, ø 4 mm

Wire Traction Bows

Extensionsbügel
Estribos para extensión
Etriers à extension
Archi per trazione



035

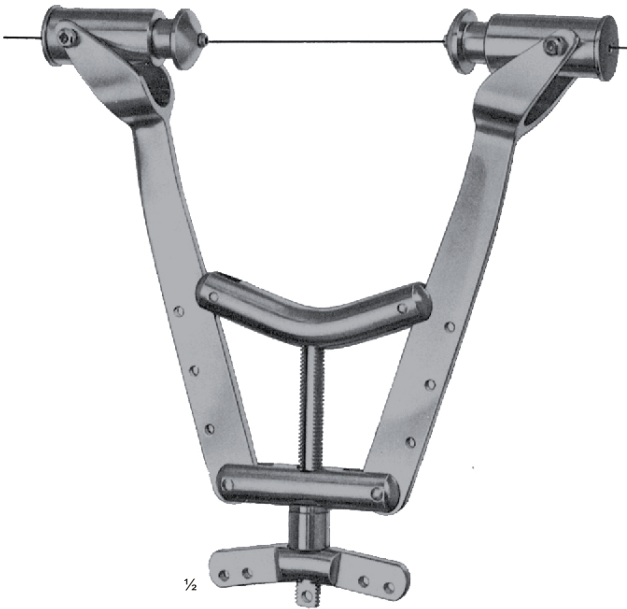

1/2

SCHRAMBERG
35-844-01
35-844-02
35-844-03



1/2

PALMER
35-846-15
15 cm, 6"



1/2

PALMER
35-846-17
17,5 cm, 7"



	Ø 5mm	
35-850-08	Ø 8cm	3 1/4"
35-850-12	Ø 12cm	4 3/4"
35-850-15	Ø 15cm	6"
35-850-17	Ø 17cm	7"
35-850-20	Ø 20cm	8"
35-850-25	Ø 25cm	10"

1/2

SCHANZ



	Ø 5mm	
35-852-15	15cm	6"
35-852-20	20cm	8"
35-852-25	25cm	10"
35-852-30	30cm	12"
35-852-35	35cm	13 3/4"
35-852-40	40cm	15 3/4"
35-852-45	45cm	17 3/4"
35-852-50	50cm	20"
35-852-55	55cm	21 1/2"
35-852-60	60cm	23 1/2"
35-852-65	65cm	25 1/2"
35-852-70	70cm	27 1/2"

PALMER
1,5 mm ø



35-854-16

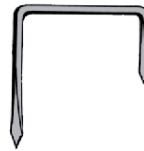

35-854-19

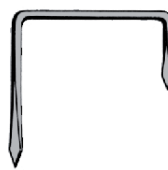

35-854-22

WILBERG
35-854-16
35-854-22



STEINMANN Pins
 STEINMANN Nägel
 STEINMANN Clavos
 STEINMANN Clous
 Chiodi STEINMANN

Drill wires
 Bohrdähte
 Taladros filiformes
 Broches filiformes
 Perforatori filiformi



035



STEINMANN

35-860-08	ø4 x 80 mm
35-860-10	ø4 x 100 mm
35-860-12	ø4 x 120 mm
35-860-14	ø4 x 140 mm
35-860-15	ø4 x 150 mm
35-860-16	ø4 x 160 mm
35-860-18	ø4 x 180 mm
35-860-20	ø4 x 200 mm
35-860-21	ø4 x 210 mm
35-860-25	ø4 x 250 mm



15 cm, 6"		31 cm, 12¼"
35-664-08	ø 0,8 mm	35-668-08
35-664-10	ø 1,0 mm	35-668-10
35-664-12	ø 1,2 mm	35-668-12
35-664-14	ø 1,4 mm	35-668-14
35-664-15	ø 1,5 mm	35-668-15
35-664-16	ø 1,6 mm	35-668-16
35-664-18	ø 1,8 mm	35-668-18
35-664-20	ø 2,0 mm	35-668-20
35-664-22	ø 2,2 mm	35-668-22
35-664-25	ø 2,5 mm	35-668-25
35-664-30	ø 3,0 mm	35-668-30



15 cm, 6"		31 cm, 12¼"
35-870-08	ø 0,8 mm	35-872-08
35-870-10	ø 1,0 mm	35-872-10
35-870-12	ø 1,2 mm	35-872-12
35-870-14	ø 1,4 mm	35-872-14
35-870-15	ø 1,5 mm	35-872-15
35-870-16	ø 1,6 mm	35-872-16
35-870-18	ø 1,8 mm	35-872-18
35-870-20	ø 2,0 mm	35-872-20
35-870-22	ø 2,2 mm	35-872-22
35-870-25	ø 2,5 mm	35-872-25
35-870-30	ø 3,0 mm	35-872-30



	10 cm, 4"	15 cm, 6"	31 cm, 12¼"
ø 0,8 mm	35-876-08	35-878-08	35-880-08
ø 1,0 mm	35-876-10	35-878-10	35-880-10
ø 1,2 mm	35-876-12	35-878-12	35-880-12
ø 1,4 mm	35-876-14	35-878-14	35-880-14
ø 1,5 mm	35-876-15	35-878-15	35-880-15
ø 1,6 mm	35-876-16	35-878-16	35-880-16
ø 1,8 mm	35-876-18	35-878-18	35-880-18
ø 2,0 mm	35-876-20	35-878-20	35-880-20
ø 2,2 mm	35-876-22	35-878-22	35-880-22
ø 2,5 mm	35-876-25	35-878-25	35-880-25
ø 3,0 mm	35-876-30	35-878-30	35-880-30



Intramedullary Pins, round, with hook
 Marknägel rund, mit haken
 Clavos intramedulares, redondos, con ganchos
 Clous médullaires, ronds, avec crochet
 Chiodi intamidollari, rotondi, con gancio



035

Length Länge Largo Longueur Lunghezza mm	2,5 mm ø	3,2 mm ø	4,8 mm ø	6,4 mm ø
25	35-890-01			
30	35-890-02			
40	35-890-03			
45	35-890-04			
50	35-890-05			
60	35-890-06			
65	35-890-07			
70	35-890-08			
75	35-890-09			
85	35-890-10			
90	35-890-11			
95	35-890-12			
100	35-890-13	35-892-13		
115	35-890-14	35-892-14		
125	35-890-15	35-892-15		
140	35-890-16	35-892-16		
150	35-890-17	35-892-17		
165	35-890-18	35-892-18		
180	35-890-19	35-892-19		
190	35-890-20	35-892-20		
205	35-890-21	35-892-21	35-894-21	
215	35-890-22	35-892-22		
220			35-894-23	
235		35-892-24		
240	35-890-25	35-892-25	35-894-25	
250				
255	35-890-27	35-892-27	35-894-27	
280			35-894-28	35-896-28
295			35-894-29	35-896-29
300				
315			35-894-31	35-896-31
335			35-894-32	35-896-32
355			35-894-33	35-896-33
375				35-896-34
395				35-896-35
410				35-896-36
430				35-896-37
Set with rack Satz mit Halter Juego can soporte Jeu aec porte-clous Set con fermo	35-890-00 25-100 mm (13)	35-892-00 100-255 mm (13)	35-894-00 205-355 mm (9)	35-896-00 280-430 mm (9)
Set with rack Satz mit Halter Juego can soporte Jeu aec porte-clous Set con fermo	35-891-00 100-255 mm (13)			
Rack, only Halter, allein Soporte, suelto Porte-clous, seul solo fermo	35-891-01 2,4 mm	35-893-01 3,2 mm	35-895-01 4,8 mm	35-897-01 6,4 mm

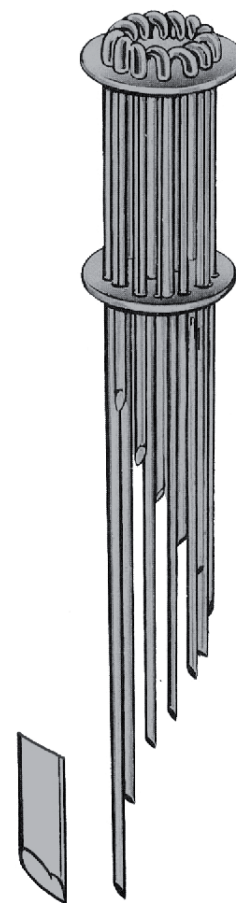



Küntscher Intramedullary Nails
 Küntscher Nägel für Oberschenkel
 Küntscher Clavos Intramedulares
 Küntscher clous pour fémur
 Chiodi di Küntscher per femore



035

With 1 eye, ,ot 1 Öse, con 1 oja, avec 1 oeillet, con 1 foro



Length Länge Largo Longueur Lunghezza	cm in	Fig. 1	Fig. 2	Fig. 3	Fig. 4	Fig. 5	Fig. 6	Fig. 7	Fig. 8	Fig. 9	Fig. 10	Fig. 11
		ø 6 mm	ø 7 mm	ø 8 mm	ø 9 mm	ø 10 mm	ø 11 mm	ø 12 mm	ø 13 mm	ø 14 mm	ø 15 mm	ø 16 mm
18 cm	7	35-900-18	35-901-18									
20 cm	8	35-900-20	35-901-20									
22 cm	8¾	35-900-22	35-901-22									
24 cm	9½	35-900-24	35-901-24	35-902-24								
26 cm	10¼	35-900-26	35-901-26	35-902-26								
28 cm	11	35-900-28	35-901-28	35-902-28								
30 cm	12	35-900-30	35-901-30	35-902-30	35-903-30		35-905-30					
32 cm	12½	35-900-32	35-901-32	35-902-32	35-903-32	35-904-32	35-905-32					
34 cm	13½	35-900-34	35-901-34	35-902-34	35-903-34	35-904-34	35-905-34	35-906-34	35-907-34	35-908-34		
36 cm	14		35-901-36	35-902-36	35-903-36	35-904-36	35-905-36	35-906-36	35-907-36	35-908-36		
38 cm	15		35-901-38	35-902-38	35-903-38	35-904-38	35-905-38	35-906-38	35-907-38	35-908-38	35-909-38	35-910-38
40 cm	15¾		35-901-40	35-902-40	35-903-40	35-904-40	35-905-40	35-906-40	35-907-40	35-908-40	35-909-40	35-910-40
42 cm	16½			35-902-42	35-903-42	35-904-42	35-905-42	35-906-42	35-907-42	35-908-42	35-909-42	35-910-42
44 cm	17¼			35-902-44	35-903-44	35-904-44	35-905-44	35-906-44	35-907-44	35-908-44	35-909-44	35-910-44
46 cm	18			35-902-46	35-903-46	35-904-46	35-905-46	35-906-46	35-907-46	35-908-46	35-909-46	35-910-46
48 cm	19			35-902-48	35-903-48	35-904-48	35-905-48	35-906-48	35-907-48	35-908-48	35-909-48	35-910-48
50 cm	19¾			35-902-50	35-903-50	35-904-50	35-905-50	35-906-50	35-907-50	35-908-50	35-909-50	35-910-50
52 cm	20½				35-903-52	35-904-52	35-905-52	35-906-52	35-907-52	35-908-52	35-909-52	35-910-52

With 2 eye, ,ot 2 Öse, con 2 oja, avec 2 oeillet, con 2 foro



Length Länge Largo Longueur Lunghezza	cm in	Fig. 1	Fig. 2	Fig. 3	Fig. 4	Fig. 5	Fig. 6	Fig. 7	Fig. 8	Fig. 9	Fig. 10	Fig. 11
		ø 6 mm	ø 7 mm	ø 8 mm	ø 9 mm	ø 10 mm	ø 11 mm	ø 12 mm	ø 13 mm	ø 14 mm	ø 15 mm	ø 16 mm
18 cm	7	35-920-18	35-921-18									
20 cm	8	35-920-20	35-921-20									
22 cm	8¾	35-920-22	35-921-22									
24 cm	9½	35-920-24	35-921-24	35-922-24								
26 cm	10¼	35-920-26	35-921-26	35-922-26								
28 cm	11	35-920-28	35-921-28	35-922-28								
30 cm	12	35-920-30	35-921-30	35-922-30	35-923-30		35-925-30					
32 cm	12½	35-920-32	35-921-32	35-922-32	35-923-32	35-924-32	35-925-32					
34 cm	13½	35-920-34	35-921-34	35-922-34	35-923-34	35-924-34	35-925-34	35-926-34	35-927-34	35-928-34		
36 cm	14		35-921-36	35-922-36	35-923-36	35-924-36	35-925-36	35-926-36	35-927-36	35-928-36		35-930-36
38 cm	15		35-921-38	35-922-38	35-923-38	35-924-38	35-925-38	35-926-38	35-927-38	35-928-38	35-929-38	35-930-38
40 cm	15¾		35-921-40	35-922-40	35-923-40	35-924-40	35-925-40	35-926-40	35-927-40	35-928-40	35-929-40	35-930-40
42 cm	16½			35-922-42	35-923-42	35-924-42	35-925-42	35-926-42	35-927-42	35-928-42	35-929-42	35-930-42
44 cm	17¼			35-922-44	35-923-44	35-924-44	35-925-44	35-926-44	35-927-44	35-928-44	35-929-44	35-930-44
46 cm	18			35-922-46	35-923-46	35-924-46	35-925-46	35-926-46	35-927-46	35-928-46	35-929-46	35-930-46
48 cm	19			35-922-48	35-923-48	35-924-48	35-925-48	35-926-48	35-927-48	35-928-48	35-929-48	35-930-48
50 cm	19¾			35-922-50	35-923-50	35-924-50	35-925-50	35-926-50	35-927-50	35-928-50	35-929-50	35-930-50
52 cm	20½				35-923-52	35-924-52	35-925-52	35-926-52	35-927-52	35-928-52	35-929-52	35-929-52



Küntscher Intramedullary Nails
 Küntscher Nägel für Oberschenkel und Oberarm
 Küntscher Clavos Intramedulares
 Küntscher clous pour fémur
 Chiodi di Küntscher per femore ed omero



035

With 1 eye, ,ot 1 Öse, con 1 oja, avec 1 oeillet, con 1 foro



Length Länge Largo Longueur Lunghezza		Fig. 1	Fig. 2	Fig. 3	Fig. 4	Fig. 5	Fig. 6	Fig. 7	Fig. 8	Fig. 9
cm	in	ø 6 mm	ø 7 mm	ø 8 mm	ø 9 mm	ø 10 mm	ø 11 mm	ø 12 mm	ø 13 mm	ø 14 mm
18 cm	7	35-940-18	35-941-18	35-942-18	35-943-18	35-944-18	35-945-18			
19 cm	7½		35-941-19	35-942-19	35-943-19	35-944-19	35-945-19			
20 cm	8	35-940-20	35-941-20	35-942-20	35-943-20	35-944-20	35-945-20			
21 cm	8¼		35-941-21	35-942-21	35-943-21	35-944-21	35-945-21			
22 cm	8½	35-940-22	35-941-22	35-942-22	35-943-22	35-944-22	35-945-22			
23 cm	9		35-941-23	35-942-23	35-943-23	35-944-23	35-945-23			
24 cm	9½	35-940-24	35-941-24	35-942-24	35-943-24	35-944-24	35-945-24	35-946-24		
25 cm	10		35-941-25	35-942-25	35-943-25	35-944-25	35-945-25	35-946-25		
26 cm	10¼	35-940-26	35-941-26	35-942-26	35-943-26	35-944-26	35-945-26	35-946-26		
27 cm	10¾		35-941-27	35-942-27	35-943-27	35-944-27	35-945-27	35-946-27	35-947-27	
28 cm	11	35-940-28	35-941-28	35-942-28	35-943-28	35-944-28	35-945-28	35-946-28	35-947-28	
29 cm	11½		35-941-29	35-942-29	35-943-29	35-944-29	35-945-29	35-946-29	35-947-29	
30 cm	12	35-940-30	35-941-30	35-942-30	35-943-30	35-944-30	35-945-30	35-946-30	35-947-30	35-948-30
31 cm	12¼		35-941-31	35-942-31	35-943-31	35-944-31	35-945-31	35-946-31	35-947-31	35-948-31
32 cm	12½		35-941-32	35-942-32	35-943-32	35-944-32	35-945-32	35-946-32	35-947-32	35-948-32
33 cm	13		35-941-33	35-942-33	35-943-33	35-944-33	35-945-33	35-946-33	35-947-33	35-948-33
34 cm	13½		35-941-34	35-942-34	35-943-34	35-944-34	35-945-34	35-946-34	35-947-34	35-948-34
35 cm	13¾		35-941-35	35-942-35	35-943-35	35-944-35	35-945-35	35-946-35	35-947-35	35-948-35
36 cm	14		35-941-36	35-942-36	35-943-36	35-944-36	35-945-36	35-946-36	35-947-36	35-948-36
37 cm	14½		35-941-37	35-942-37	35-943-37	35-944-37	35-945-37	35-946-37	35-947-37	35-948-37
38 cm	15		35-941-38	35-942-38	35-943-38	35-944-38	35-945-38	35-946-38	35-947-38	35-948-38
39 cm	15½		35-941-39	35-942-39	35-943-39	35-944-39	35-945-39	35-946-39	35-947-39	35-948-39
40 cm	15¾		35-941-40	35-942-40	35-943-40	35-944-40	35-945-40	35-946-40	35-947-40	35-948-40

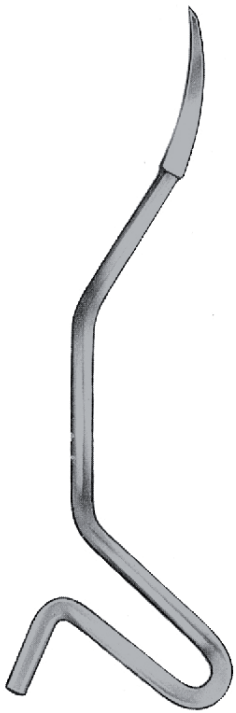

KUNTSCHER
 35-950-08 08 mm
 35-950-10 10 mm

Reamers for medullary cave

Vorbohrer zum Öffnen der Markhöhle

Perforadores para la cavidad medular

Trépans pour l'ouverture de la cavité à moelle

Alesatore per l'apertura del midollo

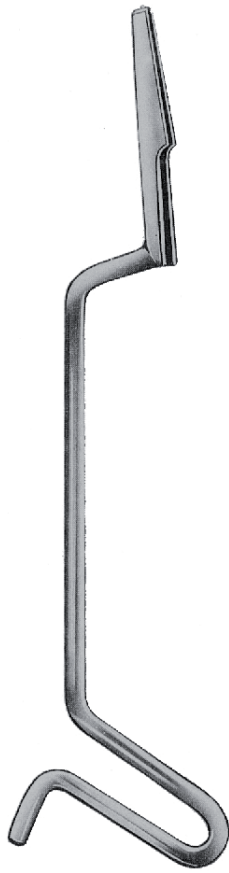

KUNTSCHER
 35-952-00

Reamer for femur
 Aufreiber für Oberschenkel
 Perforador para fémur
 Dilatateur pour fémur
 Alesatore per femore



35-956-30
 ø 3,0 mm
 35-956-35
 ø 3,5 mm
 35-956-40
 ø 4,0 mm
 35-956-50
 ø 5,0 mm

Guide pins

Führungsspieße

Guia-conductoras para clavos medulares

Pointe-guides

Guida

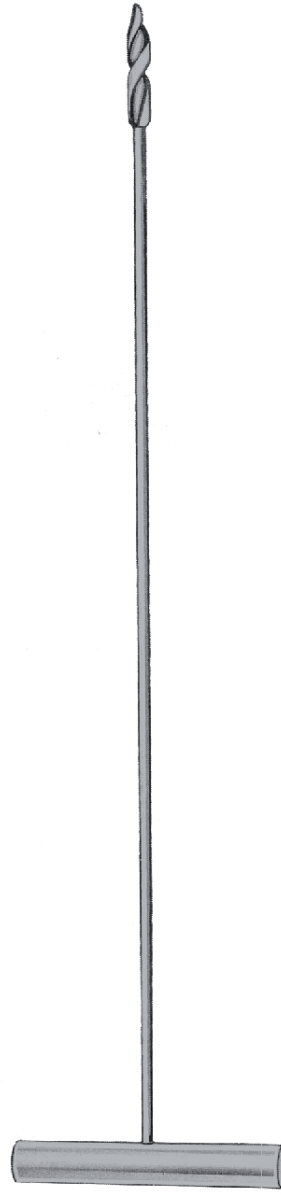

ø mm		ø mm	
06	35-960-06	14	35-960-14
07	35-960-07	15	35-960-15
08	35-960-08	16	35-960-16
09	35-960-09	17	35-960-17
10	35-960-10	18	35-960-18
11	35-960-11	19	35-960-19
12	35-960-12	20	35-960-20
13	35-960-13		

Intramedullary drills
 Markraumbohrer
 Perforadores medulares
 Trépans médullaires
 Punta intramidollare

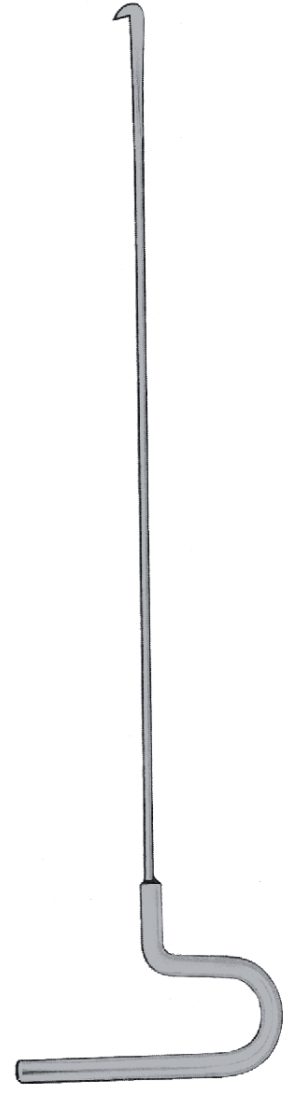

ø mm			
29	35-962-29	29 cm, 11½"	
37	35-962-37	37 cm, 14½"	
43	35-962-43	43 cm, 17"	
51	35-962-51	51 cm, 20"	

Extraction hooks
 Extraktionschaken
 Ganchos extractores
 Crochets d'extraction
 Gancio d'estrazione



½

SCHLITZHAMMER

35-970-29
 29 cm, 11½"

Slotted hammer
 Schlitzhammer
 Martillo con ranura
 Marteau avec fente
 Martello con fessura



½

VARSCHLAGER

35-972-20
 20 cm, 8"

Nail driver
 Vorschläger
 Impactor
 Impacteur
 Impattatore



½

FERTIGSCHLAGER

35-976-01 8mm
 35-976-02 12mm
 35-976-03 17mm
 19 cm, 7½"

Nail impactors
 Fertigschläger
 Impactor final
 Impacteurs finaux
 Impattatore finale

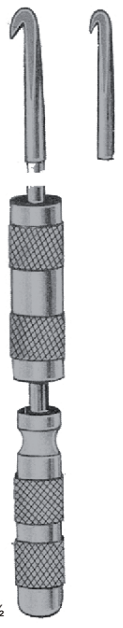

½

35-978-29

Nail extractor with 2 hooks
 Extraktor mit 2 Haken
 Aparato extractor con 2 ganchos
 Extracteur avec 2 crochets
 Estrattore con 2 ganci